

AIRTHERM MONO PUMP

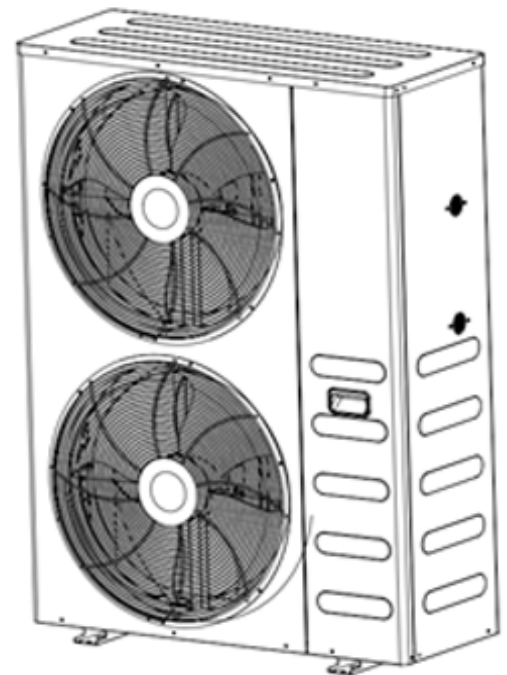
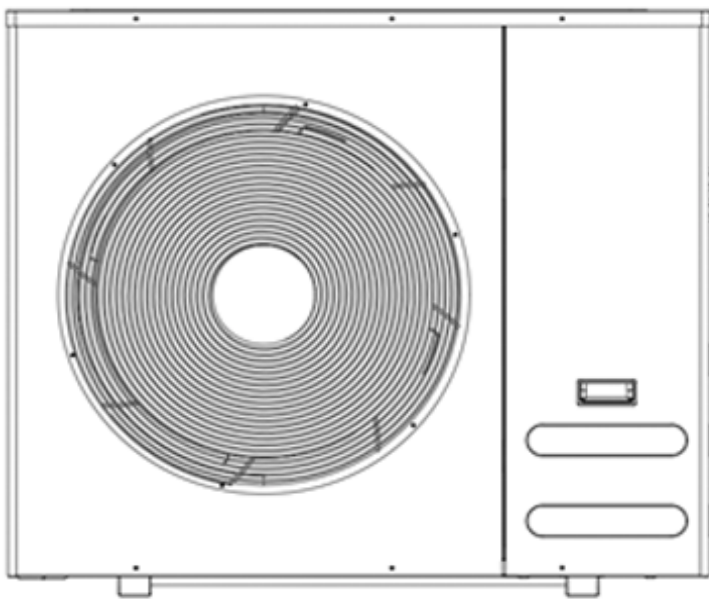

R32 DC Inverter Monoblock Air Water Heat Pump
(Heating, Cooling & Domestic Hot Water)

Airtherm MONO 9/12/15 kW

CONTENTS

1. SAFETY PRECAUTIONS	3
2. BEFORE INSTALLATION.....	7
3. IMPORTANT INFORMATION FOR THE REFRIGERANT	7
4. INSTALLATION SITE	7
4.1 Installation.....	8
5. INSTALLATION PRECAUTIONS.....	9
5.1 Dimensions	9
5.2 Installation precautions	11
6. TYPICAL APPLICATIONS	12
6.1 Application 1.....	12
7. OVERVIEW OF THE UNIT	14
7.1 Disassembling the unit.....	14
7.2 Main components.....	14
7.3 Water piping.....	15
7.4 Filling water.....	16
7.5 Water piping insulation.....	16
8. Field wiring	17
8.1 Main control.....	18
8.2 Wiring precautions and requirements	19
8.3 Connection for other components.....	20
9. FIELD SETTINGS	23
9.1 Wired controller installation	23
9.2 User Interface Field Settings.....	25
9.3 Main interface display	27
9.4 Basic Usage	27
9.5 Enquiry Menu	28
9.6 Setup Menu.....	30
9.7 User Settings.....	31
9.8 Network Configuration Guidelines	34
9.9 Smart APP	35
9.10 temp curve	39
9.11 Explanation of Abbreviations	41
10. TEST RUN AND FINAL CHECKS	42
11. MAINTENANCE AND SERVICE.....	42
12. TURN OVER TO CUSTOMER	43
13. OPERATIONAND PERFORMANCE	45
14. ERROR CODES.....	46
15. TECHNICAL SPECIFICATIONS.....	48
16. INFORMATION SERVICING	49

1. SAFETY PRECAUTIONS

The precautions listed here are divided into the following types. They are quite important, so be sure to follow them carefully. Read these instructions carefully before installation. Keep this manual in a handy for future reference.

Meanings of DANGER, WARNING, CAUTION and NOTE symbols.

INFORMATION

- Read these instructions carefully before installation. Keep this manual in a handy for future reference.
- Improper installation of equipment or accessories may result in electric shock, short-circuit, leakage, fire or other damage to the equipment.
- Be sure to only use accessories made by the supplier, which are specifically designed for the equipment and make sure to get installation done by a professional.
- All the activities described in this manual must be carried out by a licensed technician.
- Be sure to wear adequate personal protection equipment such as gloves and safety glasses while installing the unit or carrying out maintenance activities.
- Contact your dealer for any further assistance.

DANGER

- Indicates an imminently hazardous situation which if not avoided, will result in death or serious injury

WARNING

- Indicates a potentially hazardous situation which if not avoided, could result in death or serious injury.

CAUTION

- Indicates a potentially hazardous situation which if not avoided, may result in minor or moderate injury. It is also used to alert

NOTE

- Indicates situations that could only result in accidental equipment or property damage.

WARNING

- Improper installation of equipment or accessories may result in electric shock, short-circuit, leakage, fire or other damage to the equipment. Be sure to only use accessories made by the supplier, which are specifically designed for the equipment and make sure to get installation done by a certified person.
- All the activities described in this manual must be carried out by a licensed technician. Be sure to wear adequate personal protection equipment such as gloves and safety glasses while installing the unit or carrying out maintenance activities.



Caution: Risk of fire/
flammable materials

! WARNING

- Servicing shall only be performed as recommended by the equipment manufacturer. Maintenance and repair requiring the assistance of other skilled personnel shall be carried out under the supervision of the person competent in the use of flammable refrigerants.

Special requirements for R32

! WARNING

- Do NOT have refrigerant leakage and open flame.
- Be aware that the R32 refrigerant does NOT contain an odour.

! WARNING

- The appliance shall be stored so as to prevent mechanical damage and in a well-ventilated room without continuously operating ignition sources (example: open flames, an operating gas appliance) and have a room size as specified below.

🔍 NOTE

- Mechanical connectors used indoors shall comply with ISO 14903. When mechanical connectors are reused indoors, sealing parts shall be renewed. When flared joints are reused indoors, the flare part shall be re-fabricated.





! WARNING

- Make sure installation, servicing, maintenance and repair comply with instructions and with applicable legislation (for example national gas regulation) and are executed only by authorised persons.

🔍 NOTE

- Pipework should be protected from physical damage.
- Installation of pipework shall be kept to a minimum length.

Explanation of symbols displayed on the monobloc

	WARNING	This symbol shows that this appliance used a flammable refrigerant. If the refrigerant is leaked and exposed to an external ignition source, there is a risk of fire.
	CAUTION	This symbol shows that the operation manual should be read carefully.
	CAUTION	This symbol shows that a service personnel should be handling this equipment with reference to the installation manual.
	CAUTION	This symbol shows that a service personnel should be handling this equipment with reference to the installation manual.
	CAUTION	This symbol shows that information is available such as the operating manual or installation manual.

DANGER

- Before touching electric terminal parts, turn off power switch.
- When service panels are removed, live parts can be easily touched by accident.
- Never leave the unit unattended during installation or servicing when the service panel is removed.
- Do not touch water pipes during and immediately after operation as the pipes may be hot and could burn your hands. To avoid injury, give the piping time to return to normal temperature or be sure to wear protective gloves.
- Do not touch any switch with wet fingers. Touching a switch with wet fingers can cause electrical shock.
- Before touching electrical parts, turn off all applicable power to the unit.

WARNING

- Tear apart and throw away plastic packaging bags so that children will not play with them. Children playing with plastic bags face danger of death by suffocation.
- Safely dispose of packing materials such as nails and other metal or wood parts that could cause injuries.
- Ask your dealer or qualified personnel to perform installation work in accordance with this manual. Do not install the unit by yourself. Improper installation could result in water leakage, electric shocks or fire
- Be sure to use only specified accessories and parts for installation work. Failure to use specified parts may result in water leakage, electric shocks, fire, or the unit falling from its mount.
- Install the unit on a foundation that can withstand its weight. Insufficient physical strength may cause the equipment to fall and possible injury.
- Perform specified installation work with full consideration of strong wind, hurricanes, or earthquakes. Improper installation work may result in accidents due to equipment falling.
- Make certain that all electrical work is carried out by qualified personnel according to the local laws and regulations and this manual using a separate circuit. Insufficient capacity of the power supply circuit or improper electrical construction may lead to electric shocks or fire.
- Be sure to install a ground fault circuit interrupter according to local laws and regulations. Failure to install a ground fault circuit interrupter may cause electric shocks and fire.
- Make sure all wiring is secure. Use the specified wires and ensure that terminal connections or wires are protected from water and other adverse external forces. Incomplete connection or affixing may cause a fire.
- When wiring the power supply, form the wires so that the front panel can be securely fastened. If the front panel is not in place there could be overheating of the terminals, electric shocks or fire.
- After completing the installation work, check to make sure that there is no refrigerant leakage.
- Never directly touch any leaking refrigerant as it could cause severe frostbite. Do not touch the refrigerant pipes during and immediately after operation as the refrigerant pipes may be hot or cold, depending on the condition of the refrigerant flowing through
- the refrigerant piping, compressor and other refrigerant cycle parts. Burns or frostbite are possible if you touch the refrigerant pipes.
- To avoid injury, give the pipes time to return to normal temperature or, if you must touch them, be sure to wear protective gloves.
- Do not touch the internal parts (pump, backup heater, etc.) during and immediately after operation. Touching the internal parts can cause burns. To avoid injury, give the internal parts time to return to normal temperature or, if you must touch them, be sure to wear protective gloves.

CAUTION

- Ground the unit.
- Grounding resistance should be according to local laws and regulations.
- Do not connect the ground wire to gas or water pipes, lightning conductors or telephone ground wires.
- Incomplete grounding may cause electric shocks.
- Gas pipes: Fire or an explosion might occur if the gas leaks.
- Water pipes: Hard vinyl tubes are not effective grounds.
- Lightning conductors or telephone ground wires: Electrical threshold may rise abnormally if struck by a lightning bolt.
- Install the power wire at least 3 feet (1 meter) away from televisions or radios to prevent interference or noise. (Depending on the radio waves, a distance of 3 feet (1 meter) may not be sufficient to eliminate the noise.)
- Do not wash the unit. This may cause electric shocks or fire. The appliance must be installed in accordance with national wiring regulations. If the supply cord is damaged, it must be replaced by the manufacturer, its service agent or similarly qualified persons in order to avoid a hazard.
- Do not install the unit in the following places:
 - Where there is mist of mineral oil, oil spray or vapors. Plastic parts may deteriorate, and cause them to come loose or water to leak.
 - Where corrosive gases (such as sulphurous acid gas) are produced. Where corrosion of copper pipes or soldered parts may cause refrigerant to leak.
 - Where there is machinery which emits electromagnetic waves. Electromagnetic waves can disturb the control system and cause equipment malfunction.
 - Where flammable gases may leak, where carbon fiber or ignitable dust is suspended in the air or where volatile flammables such as paint thinner or gasoline are handled. These types of gases might cause a fire.
 - Where the air contains high levels of salt such as near the ocean.
 - Where voltage fluctuates a lot, such as in factories.
 - In vehicles or vessels.
 - Where acidic or alkaline vapors are present.
- This appliance can be used by children 8 years old and above and persons with reduced physical, sensory or mental capabilities or lack of experience and knowledge if they are supervised or given instruction on using the unit in a safe manner and understand the hazards involved. Children should not play with the unit. Cleaning and user maintenance should not be done by children without supervision.
- Children should be supervised to ensure that they do not play with the appliance.
- If the supply cord is damaged, it must be replaced by the manufacturer or its service agent or a similarly qualified person.
- DISPOSAL: Do not dispose this product as unsorted municipal waste. Collection of such waste separately for special treatment is necessary. Do not dispose of electrical appliances as municipal waste, use separate collection facilities. Contact your local government for information regarding the collection systems available. If electrical appliances are disposed of in landfills or dumps, hazardous substance can leak into the groundwater and get into the food chain, damaging your health and well-being.
- The wiring must be performed by certified person technicians in accordance with national wiring regulation and this circuit diagram. An all-pole disconnection device which has at least 3mm separation distance in all pole and a residualcurrent device(RCD) with the rating not exceeding 30mA shall be incorporated in the fixed wiring according to the national rule.
- Confirm the safety of the installation area (walls, floors, etc.) without hidden dangers such as water, electricity, and gas before wiring/pipes.
- Before installation , check whether the user's power supply meets the electrical installation requirements of unit (including reliable grounding , leakage , and wire diameter electrical load, etc.). If the electrical installation requirements of the product are not met, the installation of the product is prohibited until the product is rectified.
- Product installation should be fixed firmly, Take reinforcement measures, when necessary.

NOTE

- About Fluorinated Gases
 - This air-conditioning unit contains fluorinated gases. For specific information on the type of gas and the amount, please refer to the relevant label on the unit itself. Compliance with national gas regulations shall be observed.
 - Installation, service, maintenance and repair of this unit must be performed by a certified technician.
 - Product uninstallation and recycling must be performed by a certified technician.
 - If the system has a leak-detection system installed, it must be checked for leaks at least every 12 months. When the unit is checked for leaks, proper record-keeping of all checks is strongly recommended.

2. BEFORE INSTALLATION

Before installation

Be sure to confirm the model name and the serial number of the unit.

Due to relatively large dimensions and heavy weight, the unit should only be handled using lifting tools with slings. The slings can be fitted into foreseen sleeves at the base frame that are made specifically for this purpose.

CAUTION

To avoid injury, do not touch the air inlet or aluminum fins of the unit.
Do not use the grips in the fan grills to avoid damage.
The unit is top heavy! Prevent the unit from falling due to improper inclination during handling.

3. IMPORTANT INFORMATION FOR THE REFRIGERANT

This product has the fluorinated gas, it is forbidden to release to air.

Refrigerant type: R32; Volume of GWP: 675.

GWP=Global Warming Potential

Model	Factory charged refrigerant volume in the unit	
	Refrigerant/kg	Tonnes CO ₂ equivalent
9kW	1.40	0.94
12kW	1.80	1.20
15kW	1.80	1.20
18kW	2.05	1.37
22kW	2.60	1.74
25kW	3.10	2.08
30kW	3.20	2.15
34kW	4.00	2.69

CAUTION

- Frequency of Refrigerant Leakage Checks
 - Equipment that contains less than 3 kg of fluorinated greenhouse gases or hermetically sealed equipment, which is labelled accordingly and contains less than 6 kg of fluorinated greenhouse gases shall not be subject to leak checks.
 - For unit that contains fluorinated greenhouse gases in quantities of 5 tonnes of CO₂ equivalent or more, but of less than 50 tonnes of CO₂ equivalent, at least every 12 months, or where a leakage detection system is installed, at least every 24 months.
 - Only certificated person is allowed to do installation, operation and maintenance.

4. INSTALLATION SITE

WARNING

- There is flammable refrigerant in the unit and it should be installed in a well-ventilated site. If the unit is installed inside, an additional refrigerant detection device and ventilation equipment must be added in accordance with the standard EN378. Be sure to adopt adequate measures to prevent the unit from being used as a shelter by small animals.
- Small animals making contact with electrical parts can cause malfunction, smoke or fire. Please instruct the customer to keep the area around the unit clean.
- The equipment is not intended for use in a potentially explosive atmosphere.

Select an installation site where the following conditions are satisfied and one that meets with your customer's approval.

- Places that are well-ventilated.
- Places where the unit does not disturb next-door neighbors.
- Safe places which can bear the unit's weight and vibration and where the unit can be installed at an even level.
- Places where there is no possibility of flammable gas or product leak.
- The equipment is not intended for use in a potentially explosive atmosphere.

- Places where servicing space can be well ensured.
- Places where the units' piping and wiring lengths come within the allowable ranges.
- Places where water leaking from the unit cannot cause damage to the location (e.g. in case of a blocked drain pipe).
- Places where rain can be avoided as much as possible.
- Do not install the unit in places often used as a work space. In case of construction work (e.g. grinding etc.) where a lot of dust is created, the unit must be covered.
- Do not place any object or equipment on top of the unit (top plate)
- Do not climb, sit or stand on top of the unit.
- Be sure that sufficient precautions are taken in case of refrigerant leakage according to relevant local laws and regulations.- Don't install the unit near the sea or where there is corrosion gas.

When installing the unit in a place exposed to strong wind, pay special attention to the following.

Strong winds of 5 m/sec or more blowing against the unit's air outlet causes a short circuit (suction of discharge air), and this may have the following consequences:

- Deterioration of the operational capacity.
- Frequent frost acceleration in heating operation.
- Disruption of operation due to rise of high pressure.
- Motor burnout.
- When a strong wind blows continuously on the front of the unit, the fan can start rotating very fast until it breaks.

4.1 Installation

In normal condition, refer to the figures below for installation of the 9/12/5/18/22kW unit:(mm)

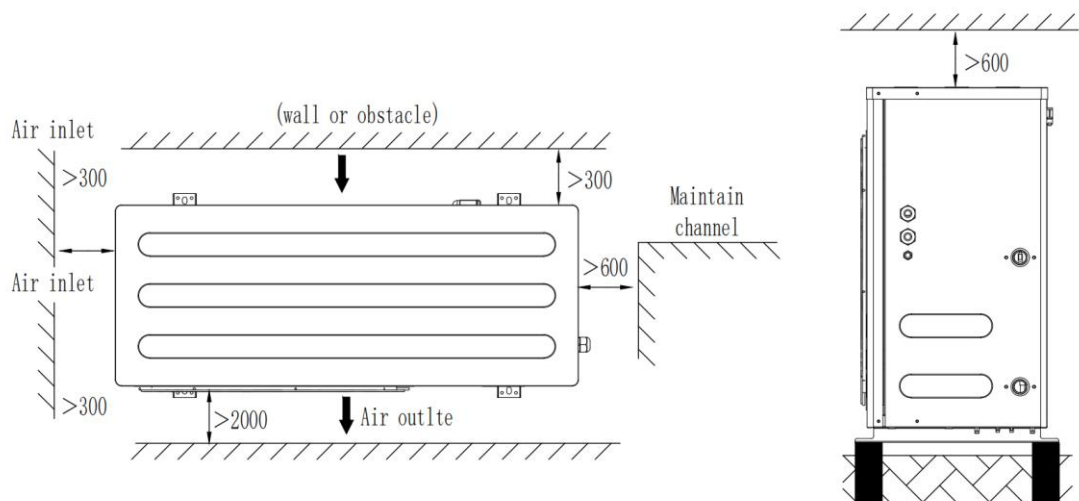

NOTE

- Make sure there is enough space to do the installation. Set the outlet side at a right angle to the direction of the wind.
- Prepare a water drainage channel around the foundation, to drain waste water from around the unit.
- If water does not easily drain from the unit, mount the unit on a foundation of concrete blocks, etc. (the height of the foundation should be about 100 mm .
- When installing the unit in a place frequently exposed to snow, pay special attention to elevate the foundation as high as possible.
- If you install the unit on a building frame, please install a waterproof plate (field supply) (about 100mm, on the underside of the unit) in order to avoid drain water dripping. (See the picture in the right)



4.1.1 Selecting a location in cold climates

NOTE

When operating the unit in cold climates, be sure to follow the instructions described below.

To prevent exposure to wind, install the unit with its suction side facing the wall.

- Never install the unit at a site where the suction side may be exposed directly to wind.
- To prevent exposure to wind, install a baffle plate on the air discharge side of the unit.
- In heavy snowfall areas, it is very important to select an installation site where the snow will not affect the unit. If lateral snowfall is possible, make sure that the heat exchanger coil is not affected by the snow (if necessary construct a lateral canopy).

4.1.2 Prevent sunshine

As the outdoor temperature is measured via the outdoor unit air thermistor, make sure to install the outdoor unit in the shade or a canopy should be constructed to avoid direct sunlight, so that it is not influenced by the sun's heat, otherwise protection may be possible to the unit.

WARNING

Uncovered scene, anti-snow shed must be installed: (1) to prevent rain and snow from hitting the heat exchanger, resulting in poor heating capacity of the unit, after long time accumulation, the heat exchanger freezes; (2) To prevent the outdoor unit air thermistor from being exposed to the sun, resulting in failure to boot; (3) To prevent freezing rain.

5. INSTALLATION PRECAUTIONS

5.1 Dimensions

5.1.1 Dimensions (9/12kW)

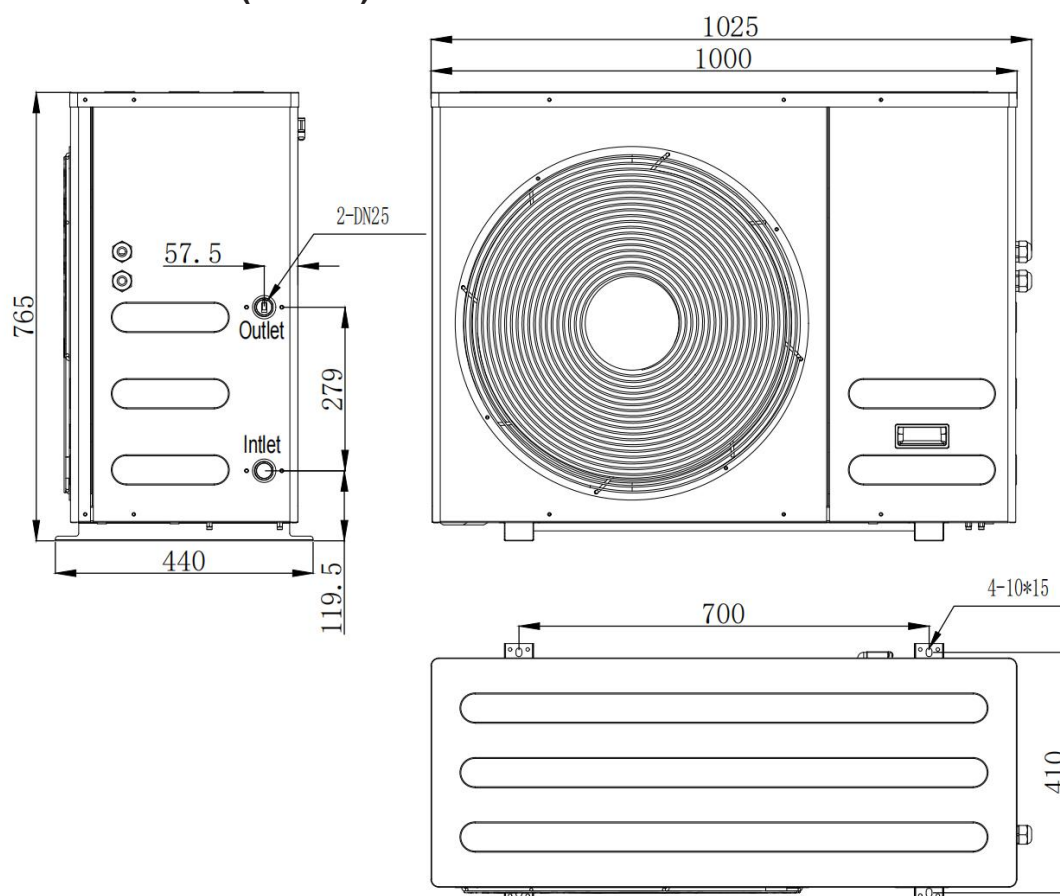

5.1.2 Dimensions (15kW)

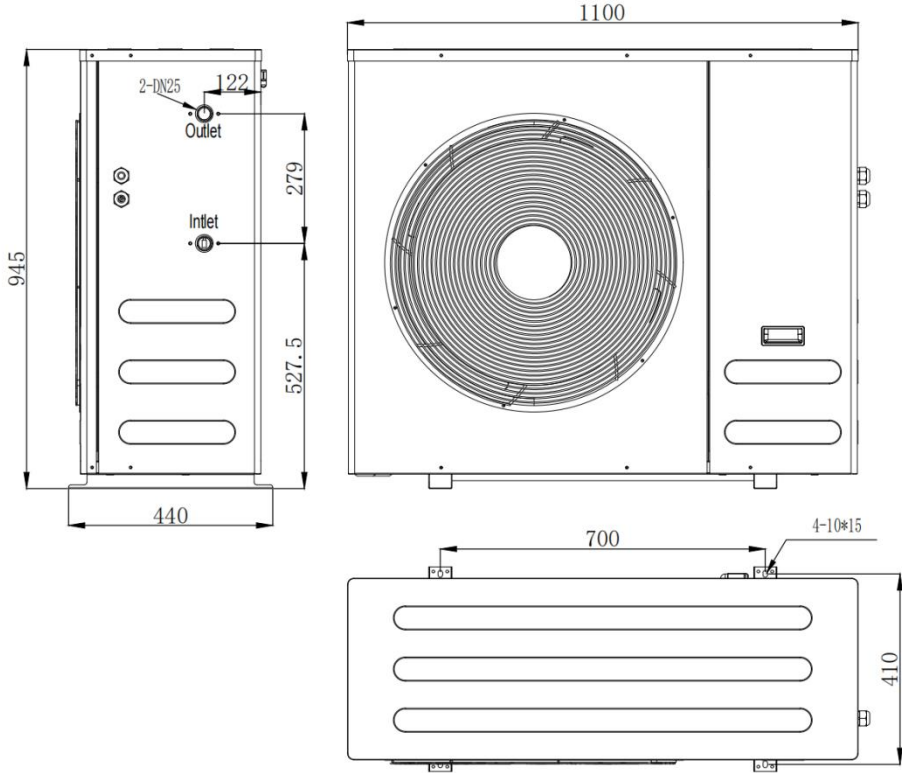

5.2 Installation precautions

5.2.1 Installation requirements

- Check the strength and level of the installation ground so that the unit may not cause any vibrations or noise during the operation.
- In accordance with the foundation drawing in the figure, fix the unit securely by means of foundation bolts. (Prepare four sets each of $\Phi 8$ Expansion bolts, nuts and washers which are readily available in the market.)
- Screw in the foundation bolts until their length is 20 mm from the foundation surface.

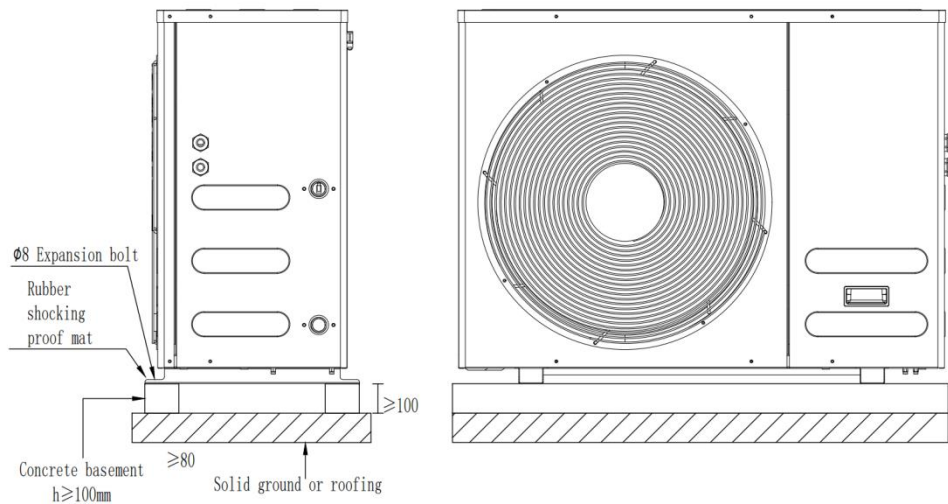

5.2.2 Drain hole position

- Unit drainage form is straight, a total of 6 drainage holes.
- According to the site situation does not need so many drainage holes, can be used to plug part of the drainage holes, if all the drainage holes open, water or not out, it is necessary to install the electric heating belt.

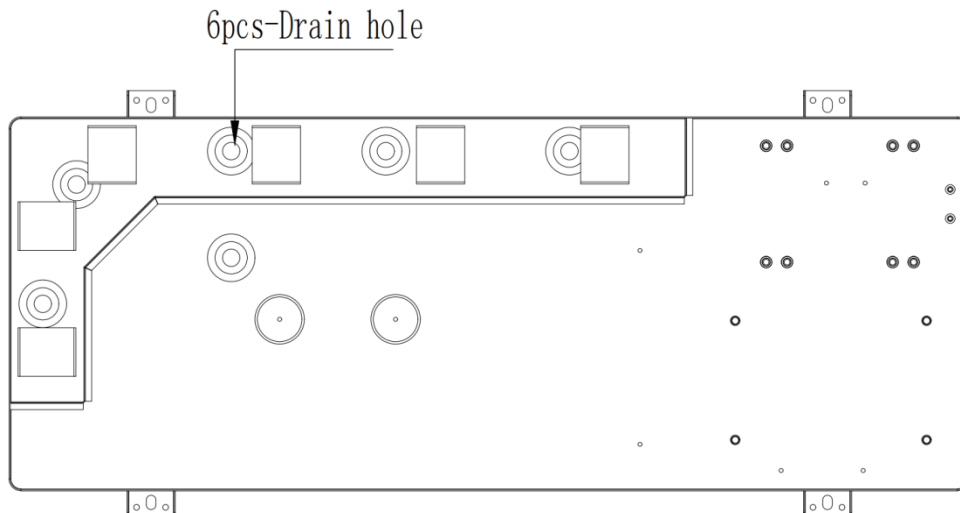

! CAUTION

- It's necessary to install an electrical heating belt if water can't drain out in cold weather even the big drain hole has opened.
- It is suggested to site the unit with the base electric heater.

6. TYPICAL APPLICATIONS

The application examples given below are for illustration only.

6.1 Application 1

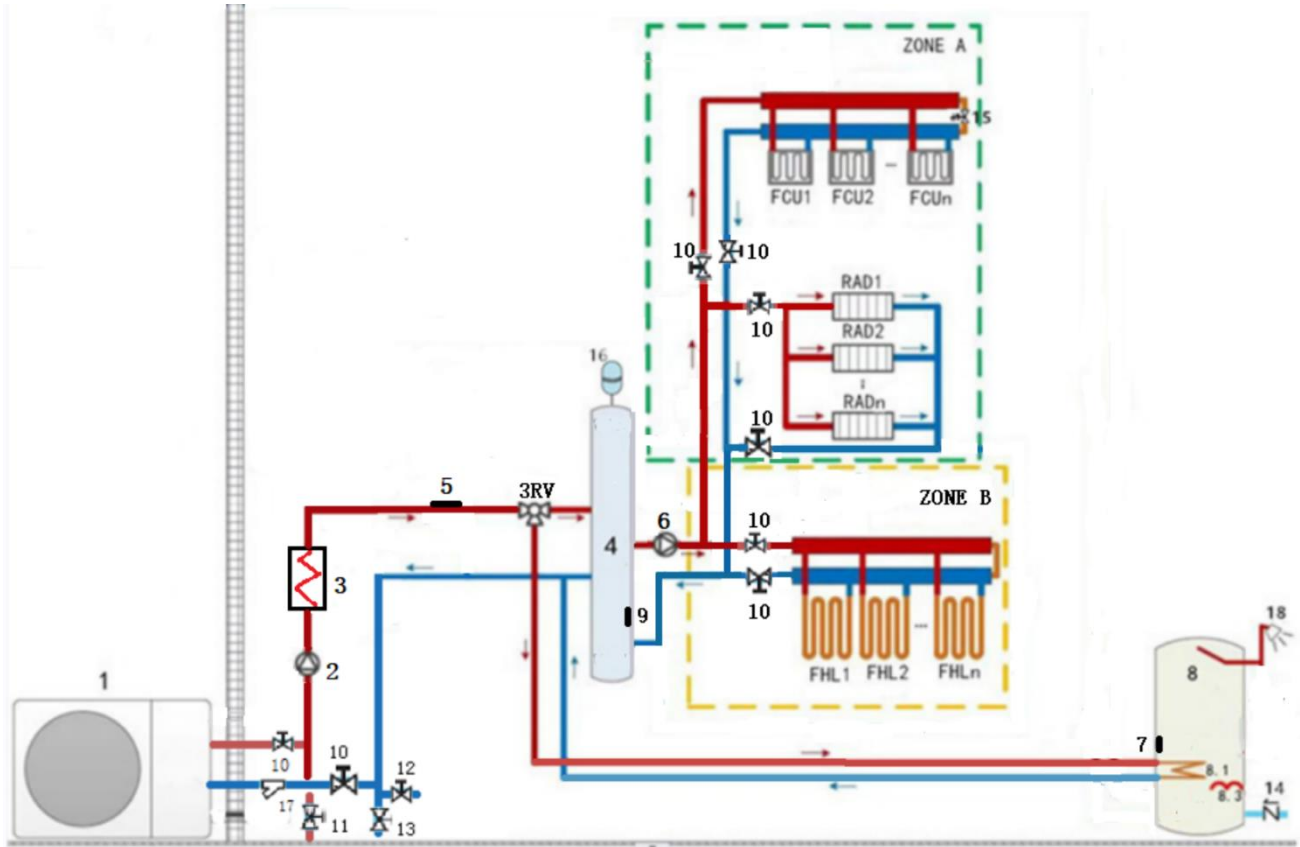

Code	Assembly unit	Code	Assembly unit
1	Outdoor unit	11	Tap water inlet pipe (Field supply)
2	Water pump	12	Drainage valve (Field supply)
3	AEH: Pipeline auxiliary electric heating	13	Tap water inlet pipe (Field supply)
4	buffer tank (Field supply)	14	Check valve (Field supply)
5	Total water flow temperature sensor(Optional)	15	Bypass valve (Field supply)
6	Heating pump	16	Expansion vessel (Field supply)
7	Water tank temperature sensor (Accessory)	17	Filter (Accessory)
8	Domestic hot water tank (Field supply)	18	Hot water tap (Field supply)
8.1	heat exchanger for heat pump	3RV	3RV:Hot water heating conversion 3-way valve (Field supply)
8.3	ETH: Domestic hot water tank booster heater (Field supply)	FCU1...n	Fan coil unit (Field supply)
9	Balance tank temperature sensor (Optional)	RAD1...n	Radiator (Field supply)
10	Filling valve (Field supply)	FHL1...n	Floor heating loop (Field supply)

- **Space heating**

The ON/OFF signal and operation mode and temperature setting are set on the user interface. Heating pump keeps running as long as the unit is ON for space heating or cooling, SV1 keeps OFF.

- **Domestic water heating**

The ON/OFF signal and target tank water temperature (Water tank temperature) are set on the user interface. Heating pump stops running as long as the unit is ON for domestic water heating, SV1 keeps ON.

- **AEH (Pipeline auxiliary electric heating) control**

The AEH function is set on the engineering contractor interface.

When the AEH is set to be valid, AEH can be turned on via Pipeline auxiliary electric heating function on the engineering contractor interface; In heating mode, AEH will be turned on automatically when the initial domestic water temperature Water heating temperature is too low or the target heating water temperature is too high at low ambient temperature.

● **ETH (tank booster heater) control**

The ETH function is set on the engineering contractor interface.

When the ETH is set to be valid, ETH can be turned on via TANK HEATER function on the engineering contractor interface; In hot water mode, ETH will be turned on automatically when the initial domestic water temperature Water tank temperature is too low or the target domestic water temperature is too high at low ambient temperature.

CAUTION

The highest outlet water temperature may reach 70°C, please beware of burns.

NOTE

Make sure to fit the (SV1) 3-way valve correctly. For more details, "Connection for other components."
 At extremely low ambient temperature, the domestic hot water is exclusively heated by ETH, which assures that heat pump can be used for space heating with full capacity.

● **The Balance tank volume requirement:**

NO.	Outdoor unit model	Balance tank (L)
1	9-12kW	≥25
2	15kW	≥25

● **When the electric heating is set to disabled, the operating range of the unit.**

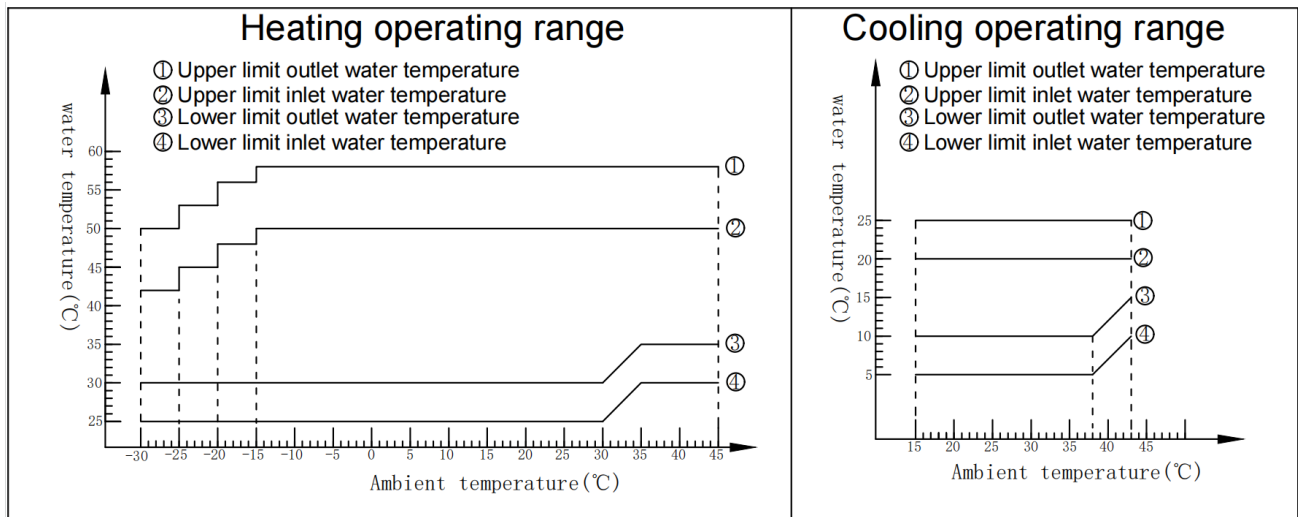

7. OVERVIEW OF THE UNIT

7.1 Disassembling the unit

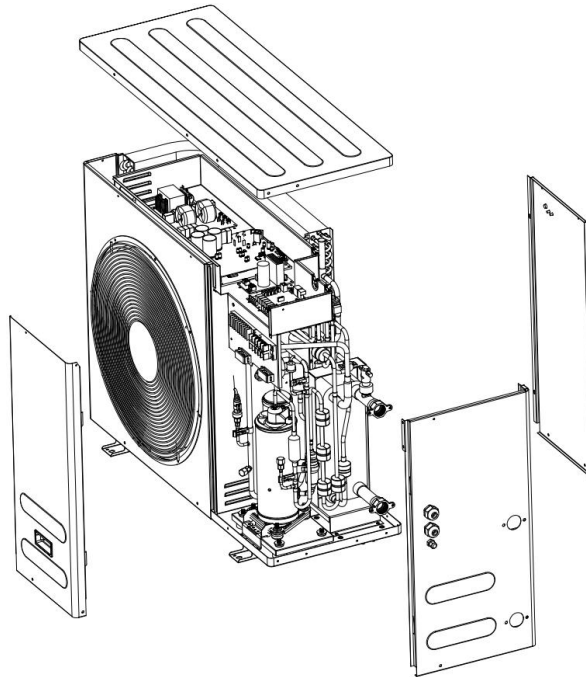

To gain access to the control box components – e.g. to connect the field wiring – the control box service panel can be removed. Thereto, loosen the front screws and unhitch the control box service panel.

⚠ CAUTION

Make sure to fix the cover with the screws and nylon washers when installing the cover .Parts inside the unit can be hot.

Switch off all power supply – i.e. outdoor unit power supply ,indoor unit power supply, electric heater and additional

7.2 Main components

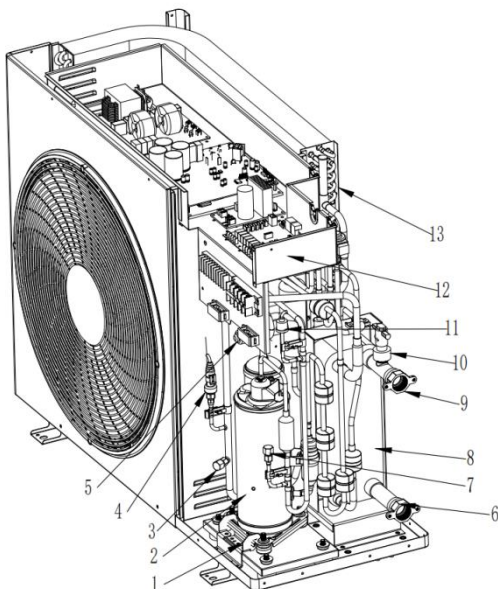

Code	Assembly unit
1	Compressor retention clip
2	Compressor
3	Low pressure side injection fluoride port
4	Low pressure pressure sensor
5	4-way valve
6	Inlet pipe
7	High pressure side needle valve
8	Plate heat exchangers
9	outlet pipe
10	Water flow switch
11	High voltage switch
12	Electric box
13	Finned heat exchangers

7.3 Water piping

NOTE

If no glycol is in the system, in case of a power supply failure or pump operating failure, drain all the water system if the water temperature is below 0°C in the cold winter (as suggested in the figure below).

When water is at standstill inside the system, freezing is very likely to happen and damage the system in the process.

7.3.1 Check the water circuit

The unit is equipped with a water inlet and water outlet for connection to a water circuit. This circuit must be provided by a licensed technician and must comply with local laws and regulations.

The unit is only to be used in a closed water system. Application in an open water circuit can lead to excessive corrosion of the water piping.

Before continuing installation of the unit, check the following:

- The maximum water pressure ≤ 3 bar.
- The maximum water temperature $\leq 70^\circ$ C according to safety device setting.
- Always use materials that are compatible with the water used in the system and with the materials used in the unit.
- Ensure that components installed in the field piping can withstand the water pressure and temperature.
- Drain taps must be provided at all low points of the system to permit complete drainage of the circuit during maintenance.
- Air vents must be provided at all high points of the system. The vents should be located at points that are easily accessible for service. An automatic air purge is provided inside the unit. Check that this air purge valve is not tightened so that automatic release of air in the water circuit is possible.

7.3.2 Water volume and sizing expansion vessels

- Check that the total water volume in the installation, excluding the internal water volume of the unit, is at least 40L.
- Expansion vessel volume must fit the total water system volume.
- To size the expansion for the heating and cooling circuit.

The expansion vessel volume can follow the figure below:

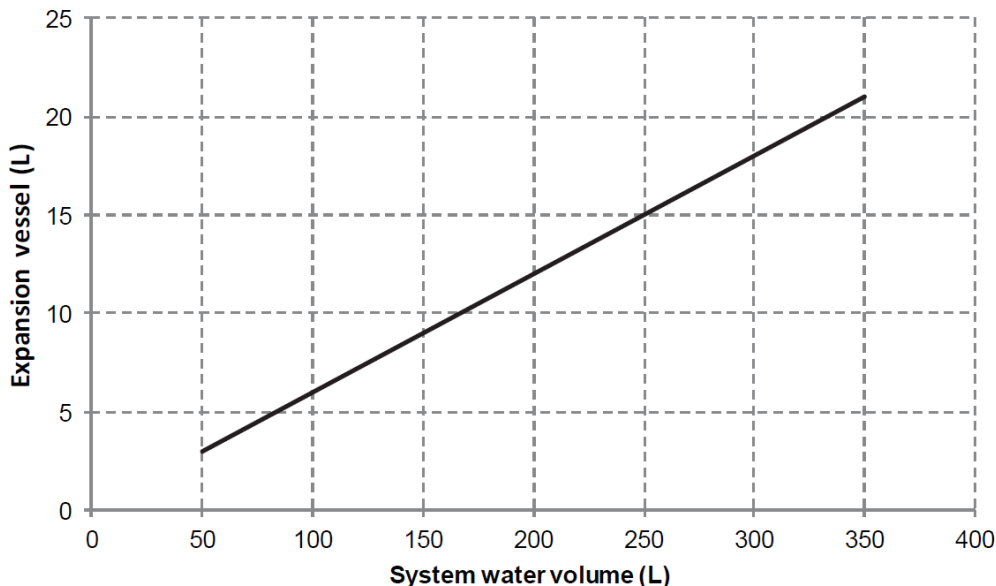

7.3.3 Water circuit connection

The unit is only to be used in a closed water system. Application in an open water circuit can lead to excessive corrosion of the water piping:

- Never use Zn-coated parts in the water circuit. Excessive corrosion of these parts may occur as copper piping is used in the unit's internal water circuit.

- When using a 3-way valve in the water circuit. Preferably choose a ball type 3-way valve to guarantee full separation between the domestic hot water and floor heating water circuit.
- When using a 3-way valve or a 2-way valve in the water circuit. The recommended maximum changeover time of the valve should be less than 60 seconds.

7.3.4 Water circuit anti-freeze protection

All internal hydronic parts are insulated to reduce heat loss. Insulation must also be added to the field piping. The software contains special functions using the heat pump and backup heater (if it is available) to protect the entire system against freezing. When the temperature of the water flow in the system drops to a certain value, the unit will heat the water, either using the heat pump, the electric heating tap, or the backup heater. The freeze protection function will turn off only when the temperature increases to a certain value.

In event of a power failure, the above features would not protect the unit from freezing.

Water may enter into the flow switch and cannot be drained out and may freeze when the temperature is low enough. The flow switch should be removed and dried, then can be reinstalled in the unit.

CAUTION

When the unit is not running for a long time, make sure the unit is powered on all the time, if you want to cut off the power, the water in the system pipe needs to be drained clean, avoid the pump and pipeline system be damaged by freezing. Also the power of the unit needs to be cut off after water in the system is drained clean.

7.4 Filling water

- Connect the water supply to the filling valves and open the valve.
- Make sure all the automatic air purge valves are open (at least 2 turns).
- Filling with water until the manometer indicates a pressure of approximately 2.0 bar. Remove air in the circuit as much as possible using the automatic air purge valves.
- During filling, it might not be possible to remove all air in the system. Remaining air will be removed through the automatic bleed valve during the first operating hours of the system. Topping up the water afterwards might be required.

Do not fasten the black plastic cover on the automatic bleed valve at the top side of the unit when the system is running. Open the automatic bleed valve, turn counterclockwise at least 2 full turns to release air from the system.

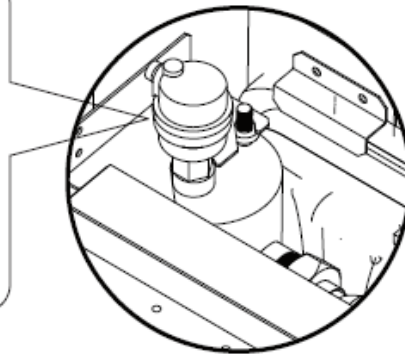

7.5 Water piping insulation

- The complete water circuit including all piping, water piping must be insulated to prevent condensation during cooling operation and reduction of the heating and cooling capacity as well as prevention of freezing of the outside water piping during winter. The insulation material should at least of B1 fire resistance rating and complies with all applicable legislation. The thickness of the sealing materials must be at least 13 mm with thermal conductivity 0.039 W/mK in order to prevent freezing on the outside water piping.
- If the outdoor ambient temperature is higher than 30°C and the humidity is higher than RH 80%, then the thickness of the sealing materials should be at least 20 mm in order to avoid condensation on the surface of the seal.

8. Field wiring

WARNING

- A main switch or other means of disconnection, having a contact separation in all poles, must be incorporated in the fixed wiring in accordance with relevant local laws and regulations. Switch off the power supply before making any connections. Use only copper wires. Never squeeze bundled cables and make sure they do not come in contact with the piping and sharp edges. Make sure no external pressure is applied to the terminal connections. All field wiring and components must be installed by a licensed electrician and must comply with relevant local laws and regulations.
- The field wiring must be carried out in accordance with the wiring diagram supplied with the unit and the instructions given below.
- Be sure to use a dedicated power supply. Never use a power supply shared by another appliance.
- Be sure to establish a ground. Do not ground the unit to a utility pipe, surge protector, or telephone ground. Incomplete grounding may cause electrical shock.
- Be sure to install a ground fault circuit interrupter (30 mA). Failure to do so may cause electrical shock.
- Be sure to install the required fuses or circuit breakers.

8.1 Main control

Table-1:1-phase

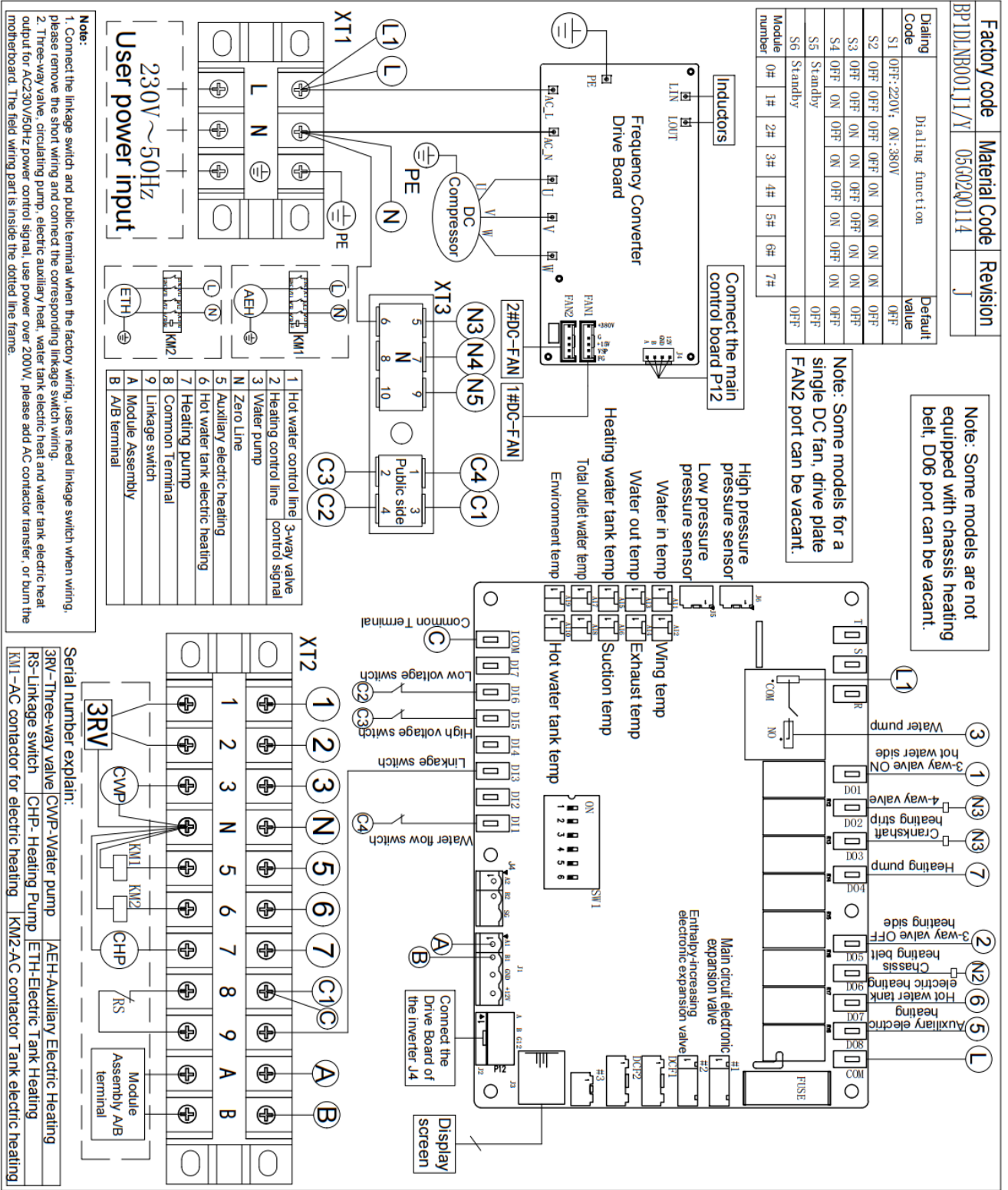

8.2 Wiring precautions and requirements

8.2.1 Precautions on electrical wiring work

- Fix cables so that cables do not make contact with the pipes (especially on the high pressure side).
- Secure the electrical wiring with cable ties as shown in figure so that it does not come in contact with the piping, particularly on the high-pressure side.
- Make sure no external pressure is applied to the terminal connectors.
- When installing the ground fault circuit interrupter make sure that it is compatible with the inverter (resistant to high frequency electrical noise) to avoid unnecessary opening of the ground fault circuit interrupter.

NOTE

The ground fault circuit interrupter must be a high-speed type breaker of 30 mA (<0.1 s).

This unit is equipped with an inverter. Installing a phase advancing capacitor not only will reduce the power factor improvement effect, but also may cause abnormal heating of the capacitor due to high-frequency waves. Never install a phase advancing capacitor as it could lead to an accident.

8.2.2 Precautions on wiring of power supply

- Use a round crimp-style terminal for connection to the power supply terminal board. In case it cannot be used due to unavoidable reasons, be sure to observe the following instructions.
- Do not connect different gauge wires to the same power supply terminal. (Loose connections may cause overheating.)
- When connecting wires of the same gauge, connect them according to the figure below.

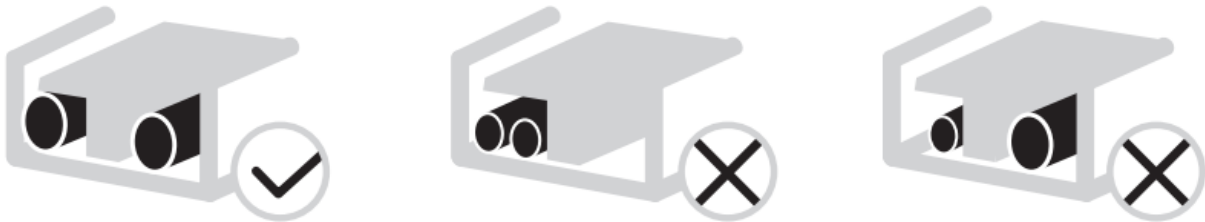

- Use the correct screwdriver to tighten the terminal screws. Small screwdrivers can damage the screw head and prevent appropriate tightening.
- Over-tightening the terminal screws can damage the screws.
- Attach a ground fault circuit interrupter and fuse to the power supply line.
- In wiring, make certain that prescribed wires are used, carry out complete connections, and fix the wires so that outside force cannot affect the terminals.

8.2.3 Safety device requirement

- Select the wire diameters(minimum value) individually for each unit based on the table 1 and table 2, where the rated current in table 1 means MCA in table 2. In case the MCA exceeds 63A, the wire diameters should be selected according to the national wiring regulation.
- Select circuit breaker that having a contact separation in all poles not less than 3 mm providing full disconnection, where MFA is used to select the current circuit breakers and residual current operation breakers:

Table 1

Rated current of appliance: (A)	Nominal cross-sectional area (mm ²)	
	Flexible cords	Cable for fixed wiring
≤3	0.5 and 0.75	1 and 2.5
>3 and ≤6	0.75 and 1	1 and 2.5
>6 and ≤10	1 and 1.5	1 and 2.5
>10 and ≤16	1.5 and 2.5	1.5 and 4
>16 and ≤25	2.5 and 4	2.5 and 6
>25 and ≤32	4 and 6	4 and 10
>32 and ≤50	6 and 10	6 and 16
>50 and ≤63	10 and 16	10 and 25

Table 2

System	Power Current							Compressor		OFM		IWPM	
	Voltage (V)	Hz	Min. (V)	Max. (V)	MCA (A)	TOCA (A)	MFA (A)	MSC (A)	RLA (A)	KW	FLA (A)	KW	FLA (A)
9kW	220-240	50	198	264	16	19	25	—	14.50	0.17	1.50	0.087	0.66
12kW	220-240	50	198	264	17	19	25	—	15.50	0.17	1.50	0.087	0.66
15kW	220-240	50	198	264	25	30	35	—	22.50	0.17	1.50	0.087	0.66

MCA : Max. Circuit Amps. (A)
TOCA: Total Over-current Amps. (A)
MFA: Max. Fuse Amps. (A)
MSC: Max. Starting Amps. (A)
RLA: In nominal cooling or heating test condition, the input Amps of compressor where MAX. Hz can operate Rated Load Amps. (A);
KW: Rated Motor Output
FLA: Full Load Amps. (A)

8.2.4 Remove the switch box cover

1-phase 9-22kW Outdoor unit and 3-phase 9-22kW Outdoor unit

Unit	Voltage (V)	Maximum overcurrent protector(MOP)(A)	Wiring size(mm ²)
9kW	220-240/1N	19	4.0
12kW	220-240/1N	19	4.0
15kW	220-240/1N	30	6.0

8.3 Connection for other components

The illustration below gives an overview of the required field wiring between several parts of the installation.

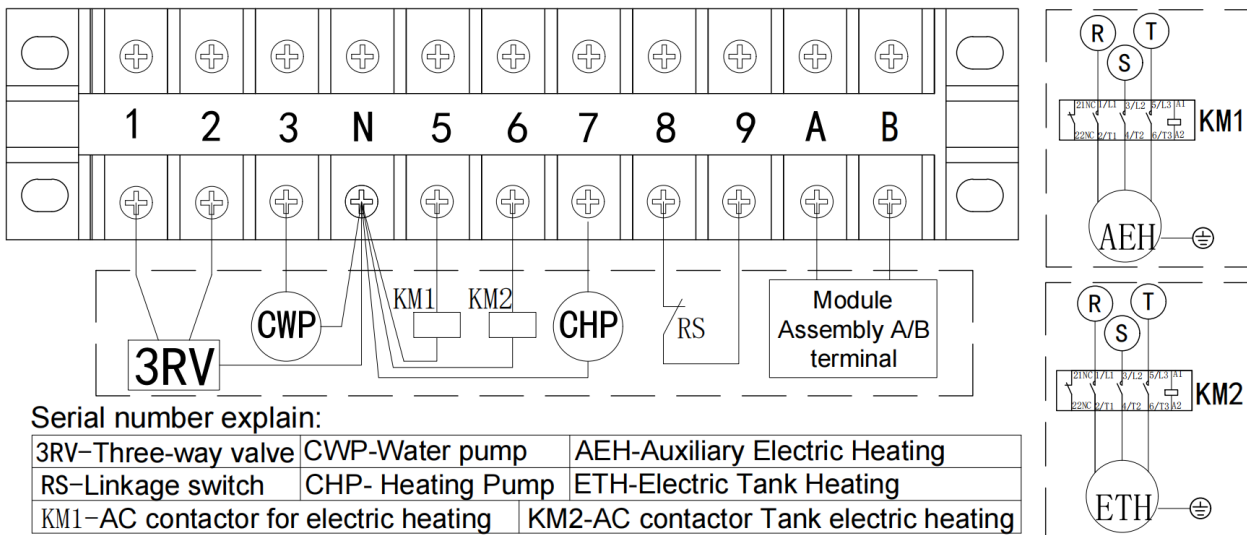

Port provide the control signal to the load. Two kind of control signal port:

Type 1: Dry connector without voltage.

Type 2: Port provide the signal with 220V voltage. If the current of load is <0.2A, load can connect to the port directly.

If the current of load is 0.2A, the AC contactor is required to connected for the load.

Minimum cable section AWG18 (0.75 mm²).

The thermistor cable are delivered with the unit: if the current of the load is large, an AC contactor is needed.

NOTE

Please use H07RN-F for the power wire, all the cables are connect to high voltage except for thermistor cable and cable for user interface.

- Equipment must be grounded.
- All high-voltage external load, if it is metal or a grounded port, must be grounded.
- All external load current is needed less than 0.2A, if the single load current is greater than 0.2A, the load must be controlled through AC contactor.

Field wiring guidelines

- Most field wiring on the unit is to be made on the terminal block inside the switch box. To gain access to the terminal block, remove the switch box service panel.
- Fix all cables using cable ties.
- A dedicated power circuit is required for the backup heater.
- Installations equipped with a domestic hot water tank (field supply) require a dedicated power circuit for the booster heater. Please refer to the domestic hot water tank Installation & Owner's Manual.
- Lay out the electrical wiring so that the front cover does not rise up when doing wiring work and attach the front cover securely.
- Follow the electric wiring diagram for electrical wiring works (the electric wiring diagrams are located on the rear side of door 2).
- Install the wires and fix the cover firmly so that the cover may be fit in properly.

WARNING

Switch off all power including the unit power supply and backup heater and domestic hot water tank power supply (if applicable) before removing the switch box service panel.

8.3.1 For 3-way valve

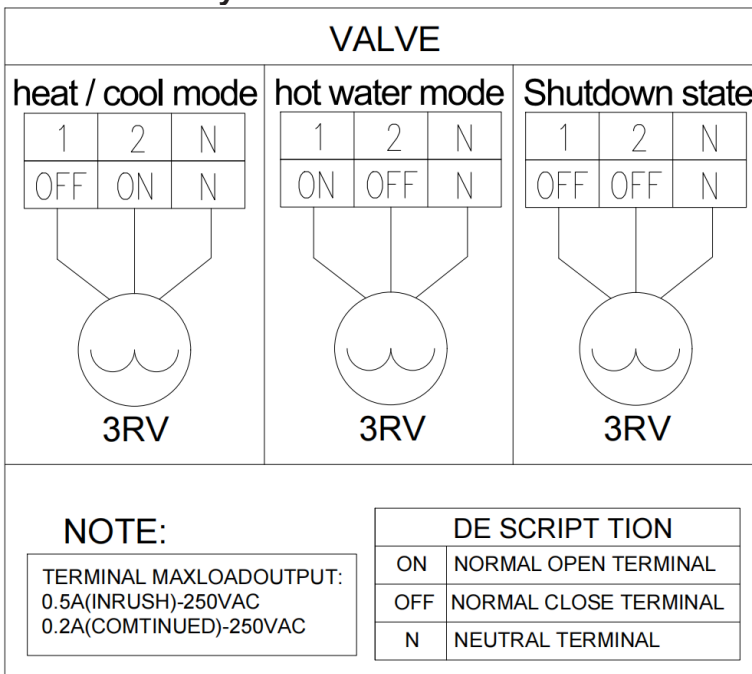

a) Procedure

- Connect the cable to the appropriate terminals as shown in the picture.
- Fix the cable reliably.

8.3.2 System parallel

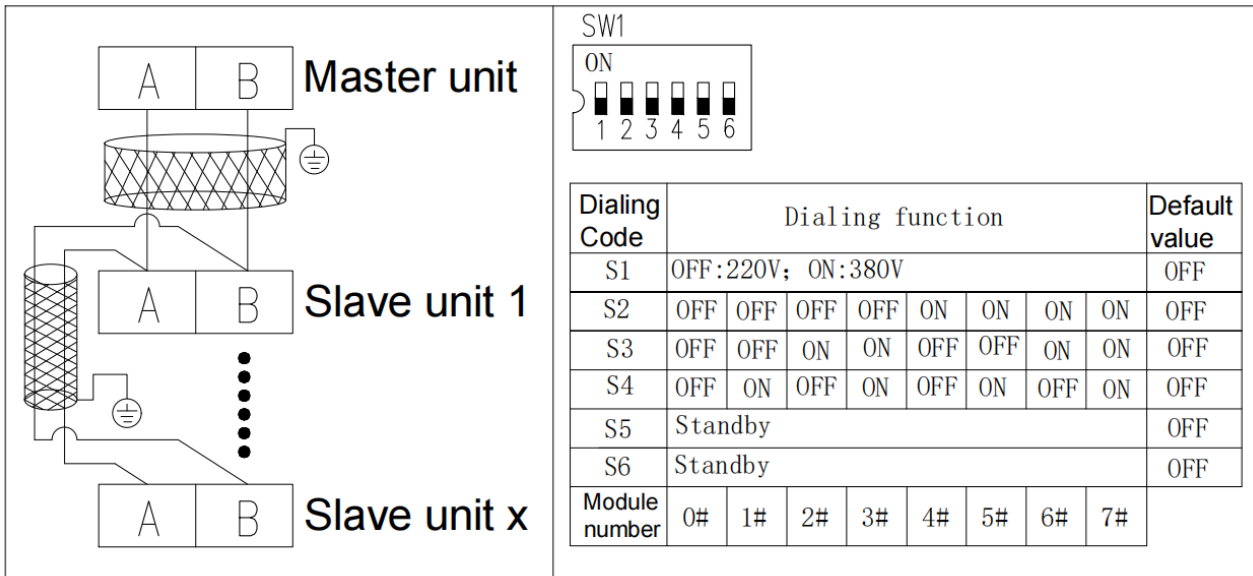

! WARNING

Switch off the power supply before opening the switch box service panel and making any changes to the DIP switch

8.3.3 External temperature probe and display connection as following:

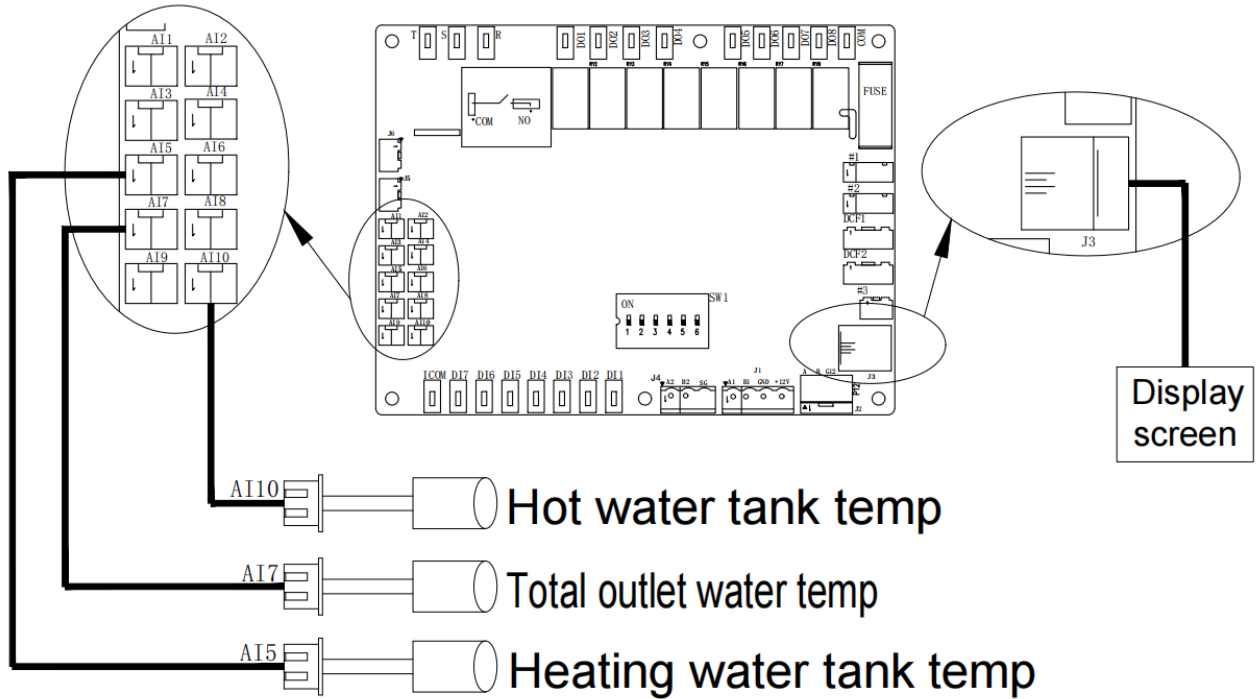

9. FIELD SETTINGS

9.1 Wired controller installation

9.1.1 Wired controller dimension

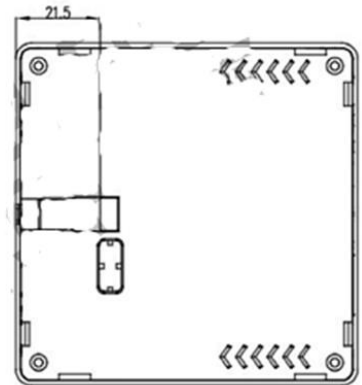
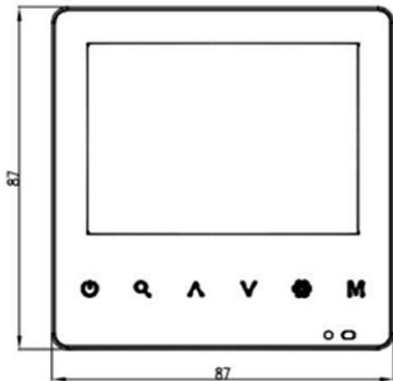

9.1.2 Wired controller installation

- Improper installation may lead to electric shock or fire.
- Re-installation must be performed by professionals, improper installation may lead to electric shock or fire.
- The wiring should adapt to the wired controller current.
- The specified cables shall be applied in the wiring. No external force may be applied to the terminal.
- Do not install the unit in a place with oil, steam, sulfide gas, otherwise, the product may deform and fail. The wired controller should be placed away from radiation.
- Circuit of Wired Remote Controller is low voltage circuit. Never connect it with a standard 220V/380V circuit or put it into a same Wiring Tube with the circuit.
- Do not attempt to extend the shielded cable by cutting. Please use Terminal Connection Block to connect them if necessary.
- Install the back cover correctly and buckle the front cover and back cover firmly, otherwise it will make the front cover drop off.
- The wire controller standard cable length is specified, or use the adapter cable

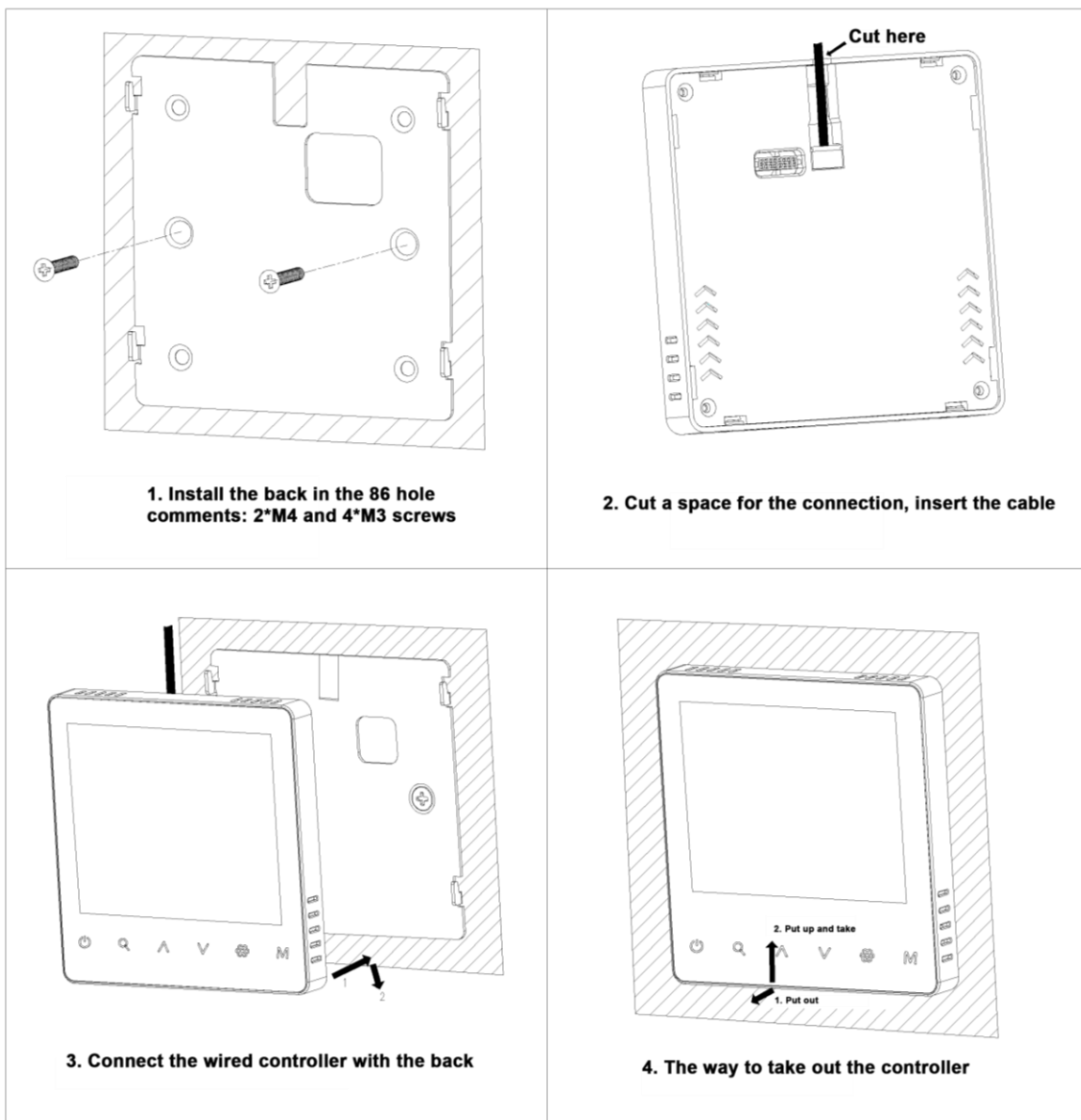

9.2 User Interface Field Settings

9.2.1 User Interface Overview

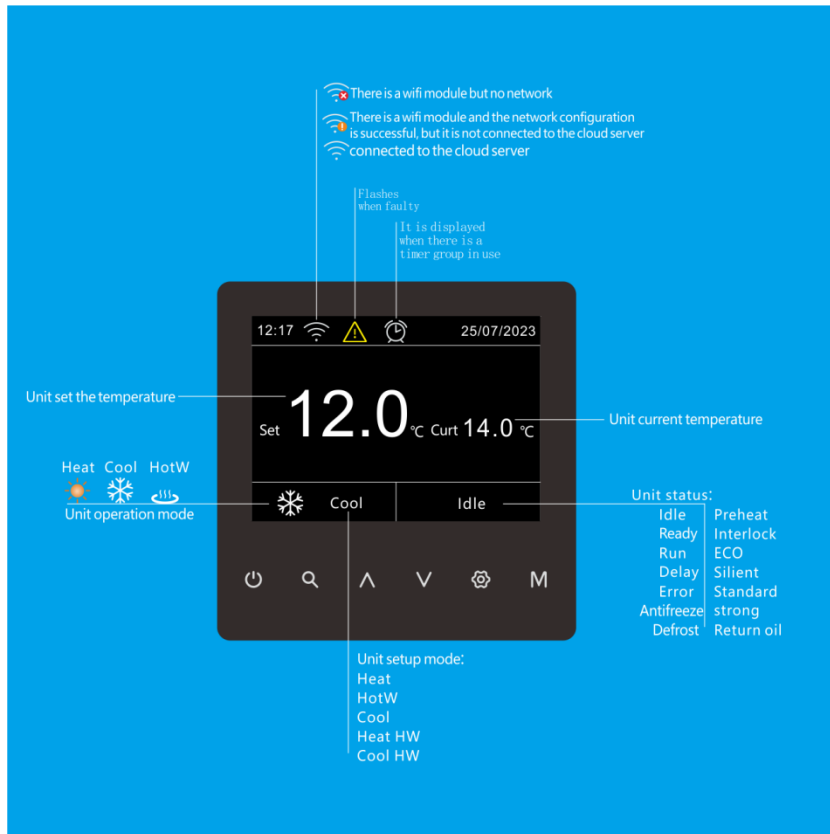

ICON	Description	Name
⏻	Turn on/off	【ON/OFF】
🔍	Enter search or Return	【Return/Search】
⬆	To last page or go up	【Up】
⬇	To next page or go down	【Down】
⚙	Setting or confirm	【Enter/Confirm】
M	Enter mode selection	【Mode】

9.2.2 Interface Hierarchy

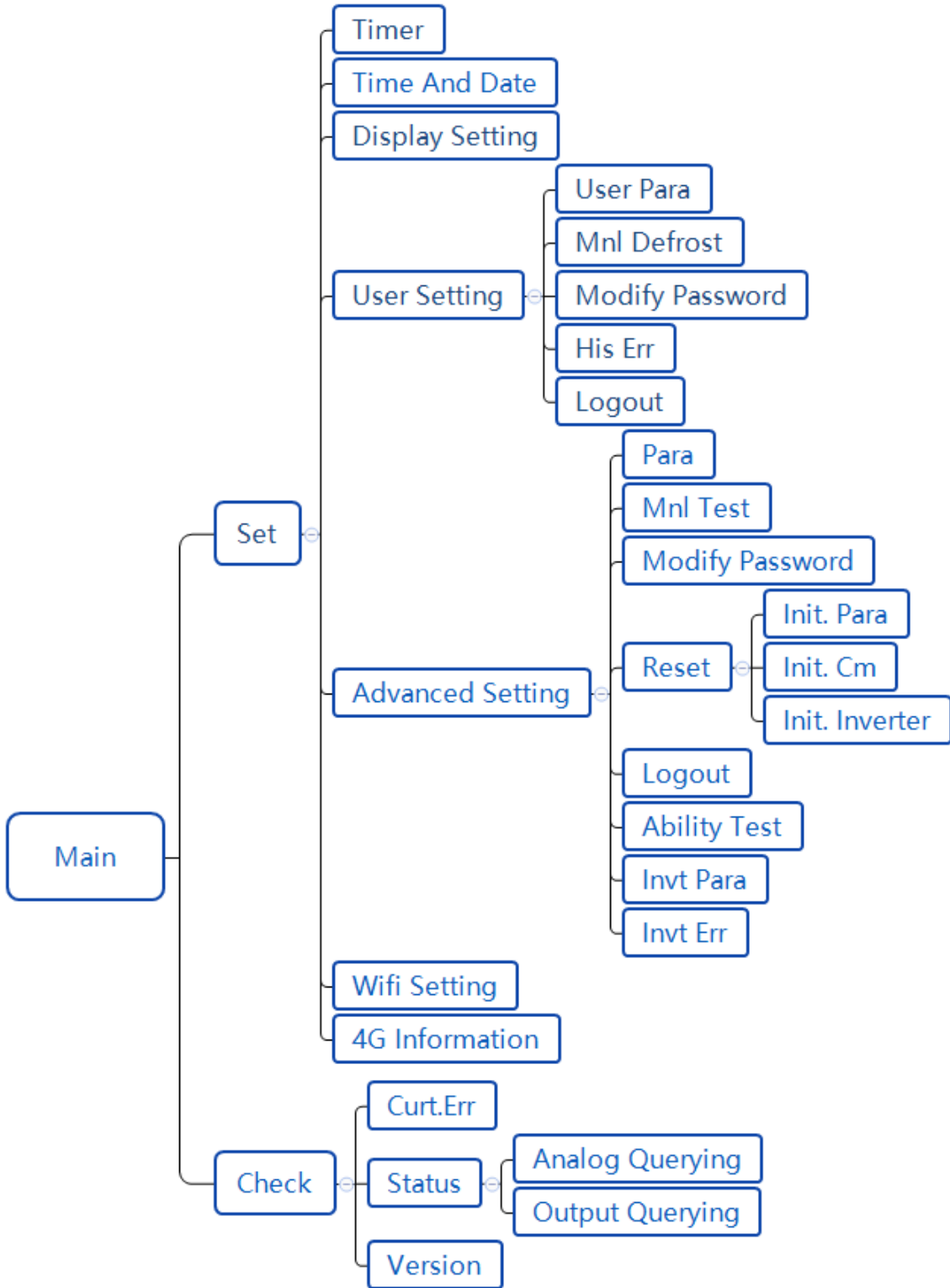

9.3 Main interface display

Depending on the application scenario, the main interface will be different, and the following describes several possible scenarios:

Main screen 1 (cooling/heating):

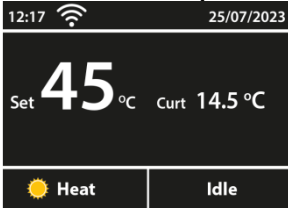

The system is heating.

Tip: All icons in the manual are used for explanatory purposes and may differ in part from what is actually on the screen.

Main screen 2 (hot water):

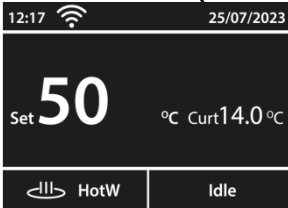

The system is hot water.

Main interface 3 (cooling + hot water):

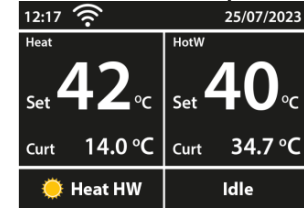

The system is "heating + hot water".

9.4 Basic Usage

9.4.1 Switching on and off

(1) Line controller switch Cooling/Heating

Click on the key in the main screen and click on to confirm switching on/off the cooling or heating.

Take heating as an example, in the main interface, click key to select heating mode, click to confirm, then press key and click to confirm to turn on the heating, as shown in Fig:

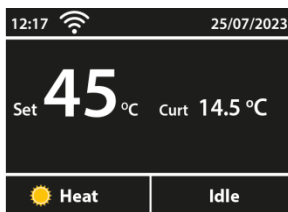
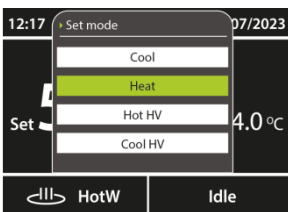

(2) Line controller switch hot water

First of all, you need to make sure that [Unit Type] is set to "Hot Water" or "Hot Water + Heating & Cooling", otherwise the hot water will not be turned on.

In the main interface, click key to select hot water mode, click to confirm, then press key and click to confirm to turn on/off the hot water production, as shown in Fig:

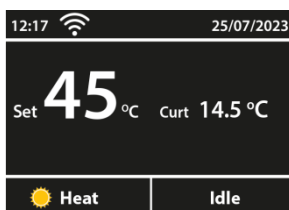
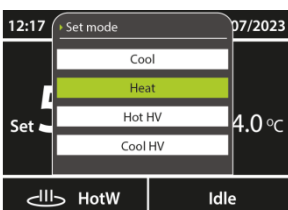

(3) Adjustment of temperature

In the main interface, click \wedge or \vee to adjust the temperature, and then click ⚙ to save the adjusted temperature value, as shown in the figure:

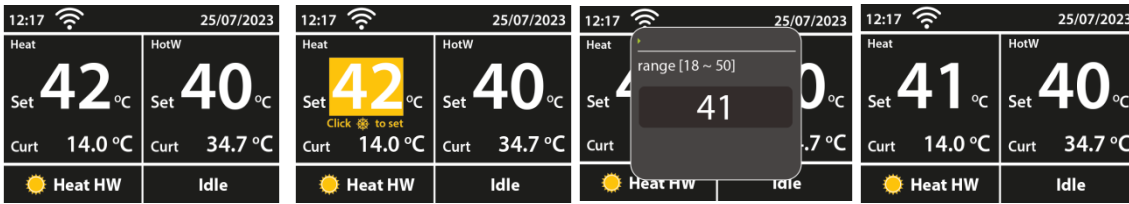

(4) Spatial mode setting

There are five spatial modes:

- ① refrigeration
- ② heat production
- ③ water heating
- ④ Cooling + hot water
- ⑤ Heating + hot water

Click M key in the main interface to pop up the space mode setting window, as shown in Fig:

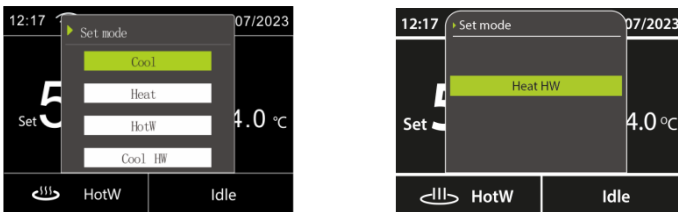

Click \wedge or \vee to select the mode you want to set, and then click ⚙ to confirm the setting is successful, if you click 🔍 , you can directly close the pop-up window and cancel this mode setting.

(5) Time Setting Operation

All the time modification (such as year, month, day, hour, minute, second) operation of this line controller is the same, here to modify the year in the date and time for example

Enter the "Date and Time" screen, please refer to 7.2 Date and Time for the path.

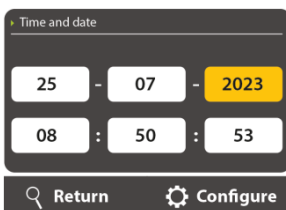

Select the year option via \wedge , \vee , and click ⚙ to bring up the year modification box.

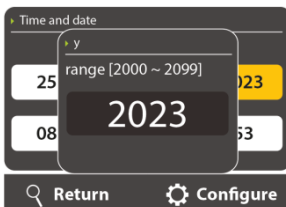

Click \wedge , \vee to modify the year value, click ⚙ to save the modification after completion of the modification, click 🔍 to close the pop-up window directly without keeping the modification.

9.5 Enquiry Menu



There are three query menus:

- 1) Fault Enquiry Screen
- 2) Status query screen
- 3) Version Search Interface

9.5.1 Fault Query Interface

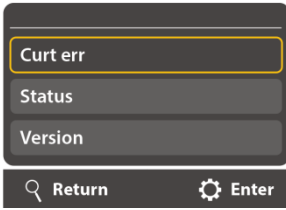
Click  in the main interface to enter the enquiry interface.



You can see the three options of fault query, status query and version query. Move through ,  and  to access the options.

When a fault exists, the fault screen is shown below (click  to eliminate faults that satisfy the reset condition).



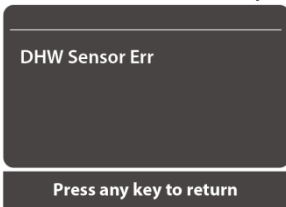

Click  to see exactly what the fault code means.

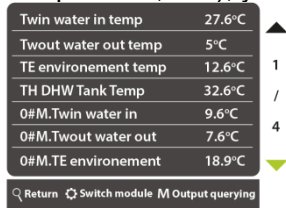

9.5.2 Status query screen

When you need to check the current status information of the unit (e.g. temperature, output of electrical components, etc.), you can enter the status query interface to check.



Click  to switch to view the switching status information (green circle on the right indicates that the component has output), and click  again to return to the analogue status information.

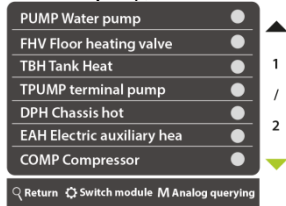

9.5.3 Version Query Screen

When dealing with some after-sales problems, in order to facilitate better positioning of the problem, it may be necessary to provide information on the software used by the unit controller, which can be viewed in the version query interface.

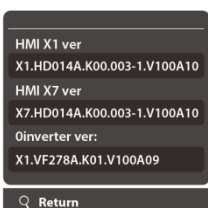





9.6 Setup Menu

9.6.1 Timing Settings





Click  in the main interface to enter the setting menu and select "Timing Setting".

Click  to access the Timing menu.

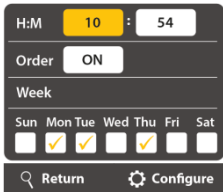

Click  or  to move through,  to use or cancel the group of timings, and  to enter the setting screen of the group of timings.



In the setting interface, click  or  to move the cursor to the information you want to set, and then click  to set the timing time (day of the week, hour and minute) and command (timer on, timer off), and then click  to return to save the setting value automatically after the setting is completed.

If the timer setting takes effect, the timer icon will be displayed at the top centre of the main interface.

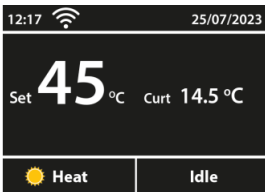

If the timer is disabled, the timer icon will not be shown in the main interface.

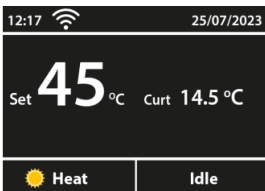

9.6.2 Date and time

If the date and time do not correspond to the actual date and time, you can change the date and time through the following path

"Main interface" > "Setting menu" > "Date and time"

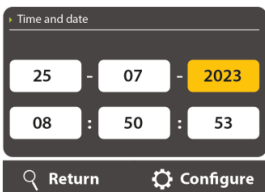

For time modification, refer to 5.5 Time Setting Operation.

9.6.3 Display Settings

Display settings can be set for daily use, such as language, screen saver brightness, screen saver time usage, etc. Enter the display settings interface through the following path.

"Main interface" > "Settings menu" > "Display settings"

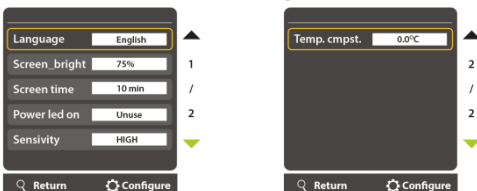

Note: If "Screen saver time" is set to 0, there is no screen saver function and the screen will stay on.

9.7 User Settings

9.7.1 User parameters

The user parameters can be used directly by the end user with the interface shown in Fig:

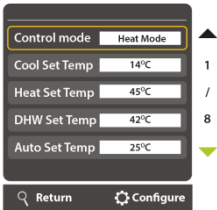

For more user parameters, please refer to the following table (actual parameters are subject to the display of the line controller):

settings item	setting range	unit (of measure)
control mode	cooling mode heating mode Hot water mode Hot water & cooling mode Hot water & heating mode	/
Refrigeration Setting Temperature	min...max	°C
Heating Setting Temperature	min...max	°C
Hot water setting temperature	min...max	°C
Thermostatic Setting Temperature	16...30	°C
power mode (of an electrical device etc)	Standard Model High Power Mode Energy Saving Mode	/
silent mode	prohibition on use Mute at night total silence	/
Night time silent on time	0~23	hour
Mute night time scoring	0~59	min
Mute off at night	0~23	hour
Night Mute Off Score	0~59	min
Duty function enable	prohibition on use start using	/
Heating duty temperature	18~50	°C
Cooling duty temperature	10~22	°C
When the segment is activated on duty	0~23	hour
Duty-commissioning segment	0~59	min
When the duty station is out of service	0~23	hour
Duty deactivation segment	0~59	min
Heating 2-way interlock	prohibition on use start using	/
Lock Screen Function Setting	prohibition on use start using	/
Alarm tone setting	noisy fig. long reverberating sound Ten seconds. Cycle time 10 seconds	/
Pump operation mode	run all the time Temperature to stop intermittent operation	/
End Pump Enable	prohibition on use start using	/
Maximum Holding Operation	0~999	min
Minimum refrigeration time	0~999	min
Minimum heating time	0~999	min
Maximum time for hot water	0~999	min
Heat pump set temperature	30~60	°C

Number of modules	1~8	pcs
00# Module Setup	prohibition on use start using	/
Press full open temperature difference	0~20	°C
Energy control cycle	0~999	second
Sterilization Function Usage Week	Sunday Monday Tuesday Wednesdays Thursdays Fridays Saturdays	/
Sterilization function hours of use	0~23	hour
Sterilization function minutes of use	0~59	min
Timed sterilisation function	prohibition on use start using	/

9.7.2 Preset temperature curve selection

Use \wedge and \vee to select it and press ⚙ to change the settings. The suitable curve can save the energy and improve the efficiency.

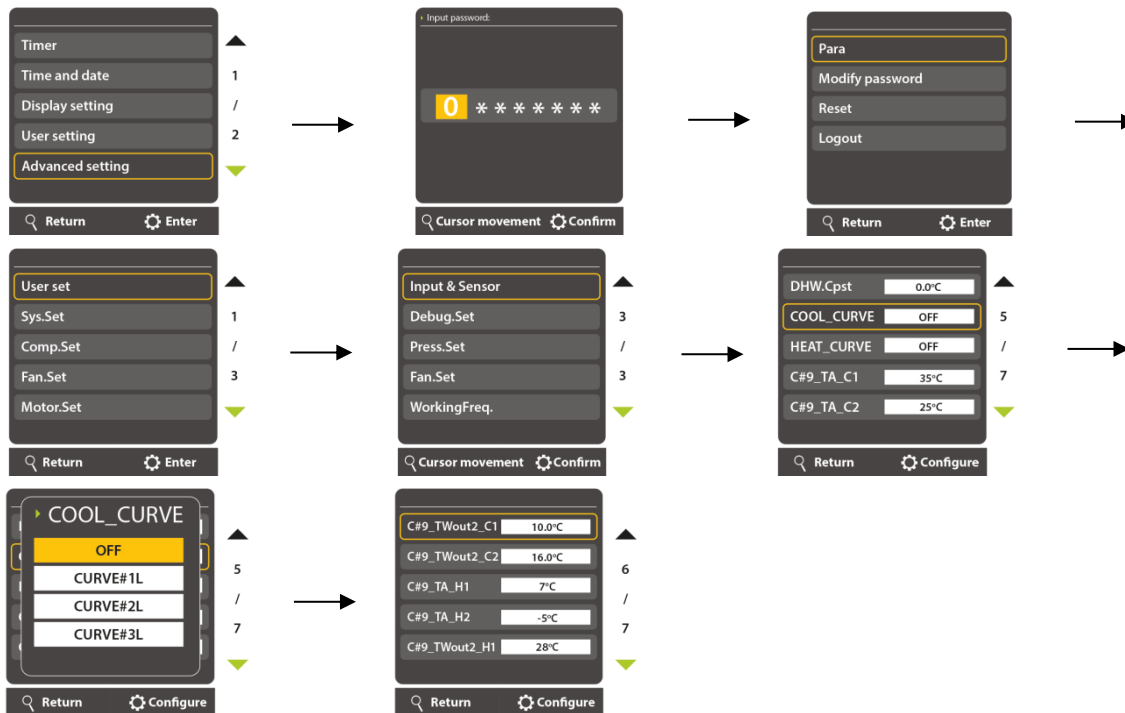

Note:

There are two types of preset temperature curves, cooling and heating.

The heating temperature curves can be set with 9 kinds curves, including 8 low temperature curves, 8 high temperature curves and one set of User-defined curve.

The cooling temperature curves can be set with 9 kinds curves, including 8 low temperature curves, 8 high temperature curves and one set of User-defined curve.

The curves are given in the table in 10.7 temp curve Please go to 10.7 temp curve to check them.

Item	Setting	Unit
COOL- CURVE	OFF CURVE#1.L CURVE#2.L CURVE#3.L CURVE#4.L CURVE#5.L CURVE#6.L CURVE#7.L CURVE#8.L CURVE#1.H CURVE#2.H CURVE#3.H CURVE#4.H CURVE#5.H CURVE#6.H CURVE#7.H CURVE#8.H CURVE#9	
HEAT- CURVE	CURVE#1.L CURVE#2.L CURVE#3.L CURVE#4.L CURVE#5.L CURVE#6.L CURVE#7.L CURVE#8.L CURVE#1.H CURVE#2.H CURVE#3.H CURVE#4.H CURVE#5.H CURVE#6.H CURVE#7.H CURVE#8.H CURVE#9	
C#9-TA-C1	-5...46	35°C
C#9-TA-C2	-5...46	25°C
C#9-TWout2-C1	5...25	10°C
C#9-TWout2-C2	5...25	16°C
C#9-TA-H1	-25...35	7°C
C#9-TA-H2	-25...35	-5°C
C#9-TWout2-H1	25...65	28°C
C#9-TWout2-H2	25...65	35°C

9.7.3 Manual defrosting

The unit operates normally with an intelligent (automatic) defrost function, but in some cases it may be necessary to use the manual defrost function, which is available via the following path.

"Main Interface" > "Setup Menu" > "User Settings" > "Manual Defrost", as shown in the figure:

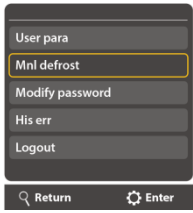

Click to enter the manual defrost setting interface, which will display the current status of each module, such as stopped running, running, defrosting.

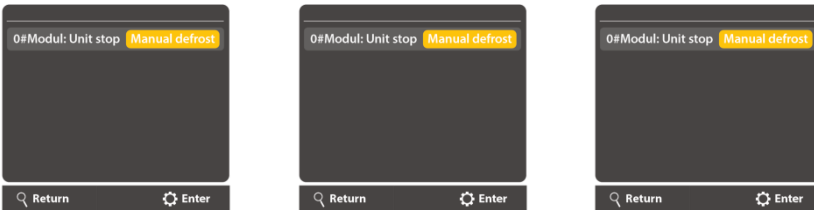

Only when the module is running and the water temperature, fin temperature, etc. meet the conditions, click to successfully enter the defrost, then the current state of the module will be switched to defrosting. Otherwise, the module will remain in its original state.

9.7.4 Historical Fault Query

For the faults that have occurred in the unit (including reset completion faults) are recorded in the controller and are queried as follows:

Firstly, through the path "Main Interface" > "Setting Menu" > "User Setting" > "Historical Fault Query", click to enter the historical fault interface.



Through this interface you can see the code of each fault in the past, the time of occurrence, click will clear all the historical faults, please be careful. Click **M** to see the specific meaning of the fault code.

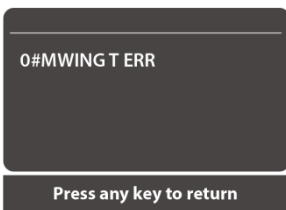

9.8 Network Configuration Guidelines

This line controller has a built-in WIFI module, which can establish communication with mobile phone APP and use mobile phone APP to operate the unit.

When you configure the line controller to WIFI network for the first time, you first need to make sure that the line controller is within the same WIFI signal as your mobile phone, and the signal cannot be too weak. Through "Main Interface" > "Setting Menu" > "WIFI Setting", click to enter the network information interface. The interface displays the current WIFI status, MAC address, and instructions on how to configure the network.

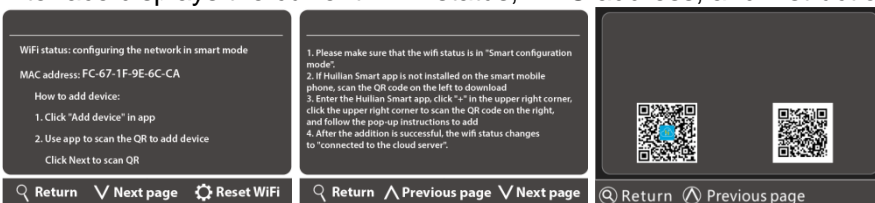

If the WIFI status (WIFI status) shows "Connected to cloud server", the line controller has been provisioned and can be operated on the account where the provisioning was previously completed.

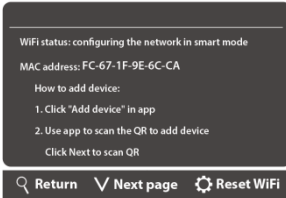

If the WIFI status displays something else or if you need to cancel a previously completed pairing, you can follow the steps below (Note: Accounts that have been successfully paired and communicated with will no longer be able to operate the unit).

Click  on the first page of the distribution information interface, and wait until the WIFI status shows "Distributing in Smart Mode", you can use the mobile phone APP to carry out the distribution and connection operation, please refer to the "Pocket Wisers APP.Device Distribution Instruction Manual" for details.

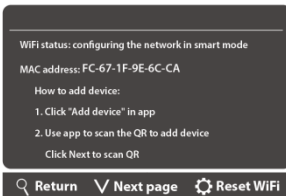

9.9 Smart APP

(1) Connect Your Phone to Wi-Fi

Make sure that the mobile phone and the device to be connected are in the same Wi-Fi environment. Select the 2.4GHz Wi-Fi network on the mobile phone and enter the password to connect the mobile phone to the network.

NOTE

If the Wi-Fi in the current environment is 5GHz, please set the router to 2.4GHz first.

(2) Add Device

- Turn on the mobile phone Wi-Fi and Bluetooth, and enable location access, please make sure that the mobile phone Wi-Fi and Bluetooth are both turned on to obtain the best network configuration test;
- Open the **Huilian Smart** APP on the mobile phone, and select "**Home**" in the bottom navigation bar;
- Click the "+" button in the upper right corner of the home page, or click the "**Add Device**" button in the center of the home page to enter the device adding interface;

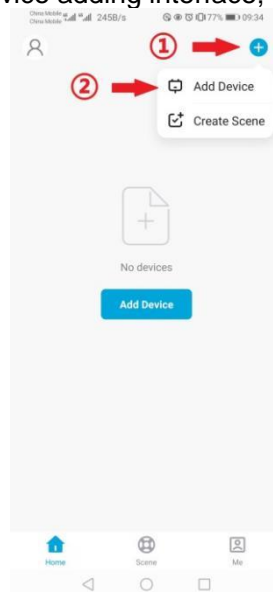

- In the device adding interface, please try to add the device in one of the following ways:

➤ Automatic device discovery

The phone will automatically discover available devices nearby. After discovering the device, follow the instructions in the figure below to complete the subsequent network configuration operations.

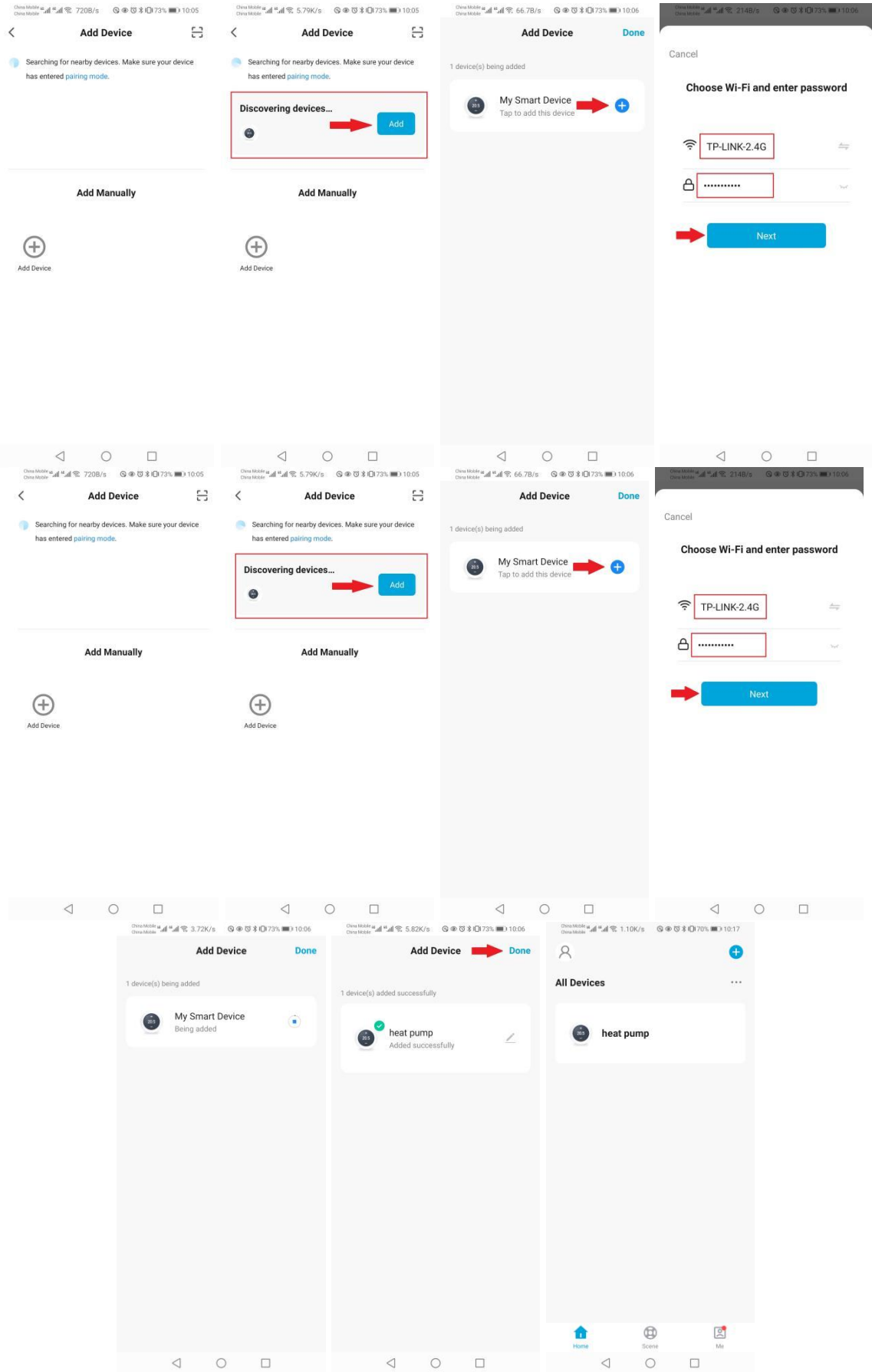

➤ **Scan QR code to add device**

Click the "Scan" icon in the upper right corner of the device adding interface, put the **device network QR code** in the box to scan it automatically, and follow the steps to complete the device adding.

NOTE

- Please obtain the **QR code of the equipment distribution network** from the corresponding manufacturer's instruction manual of the product.
- If you have checked and confirmed that the **WIFI status** of the device is correct, under the step of "**Reset the device**", please directly check "**Confirm the WIFI status**"
- And click the "**Next**" button to directly configure the network without the need to reset the device.

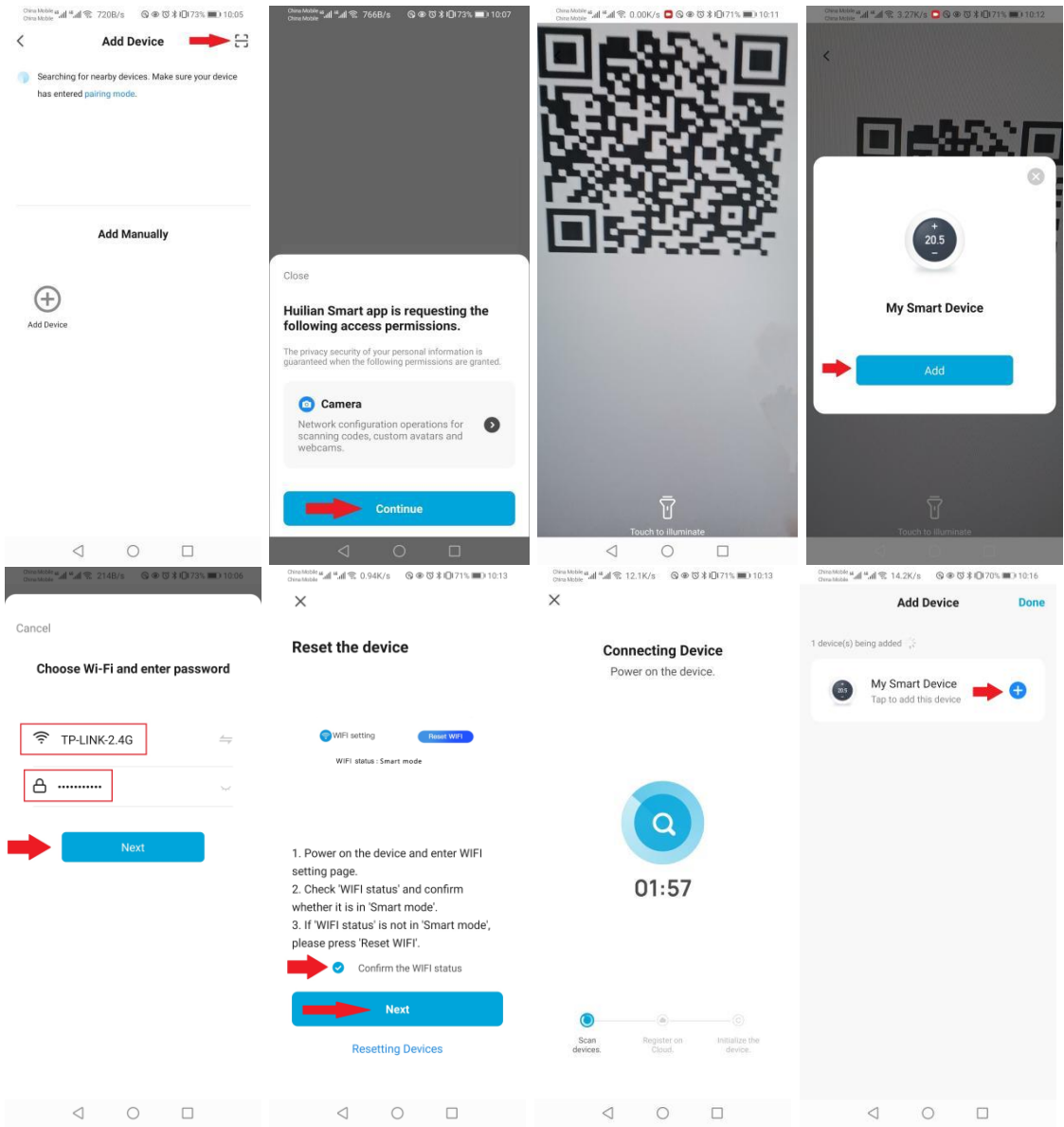

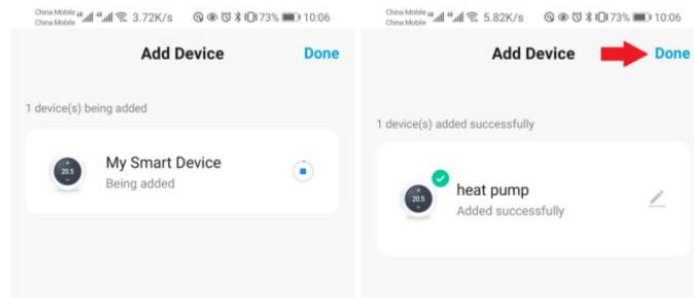

➤ **Manually adding devices**

In the tab bar at the top of the device adding interface, select **"Add Manually"**, and select the **"Add Device"** icon button to manually add it. The following figure guides you to add a device.

NOTE

If you have checked and confirmed that the WIFI status of the device is correct, under the step of **"Reset the device"**, please directly check **"Confirm WIFI status"** and click the **"Next"** button to directly configure the network without the need to reset the device.

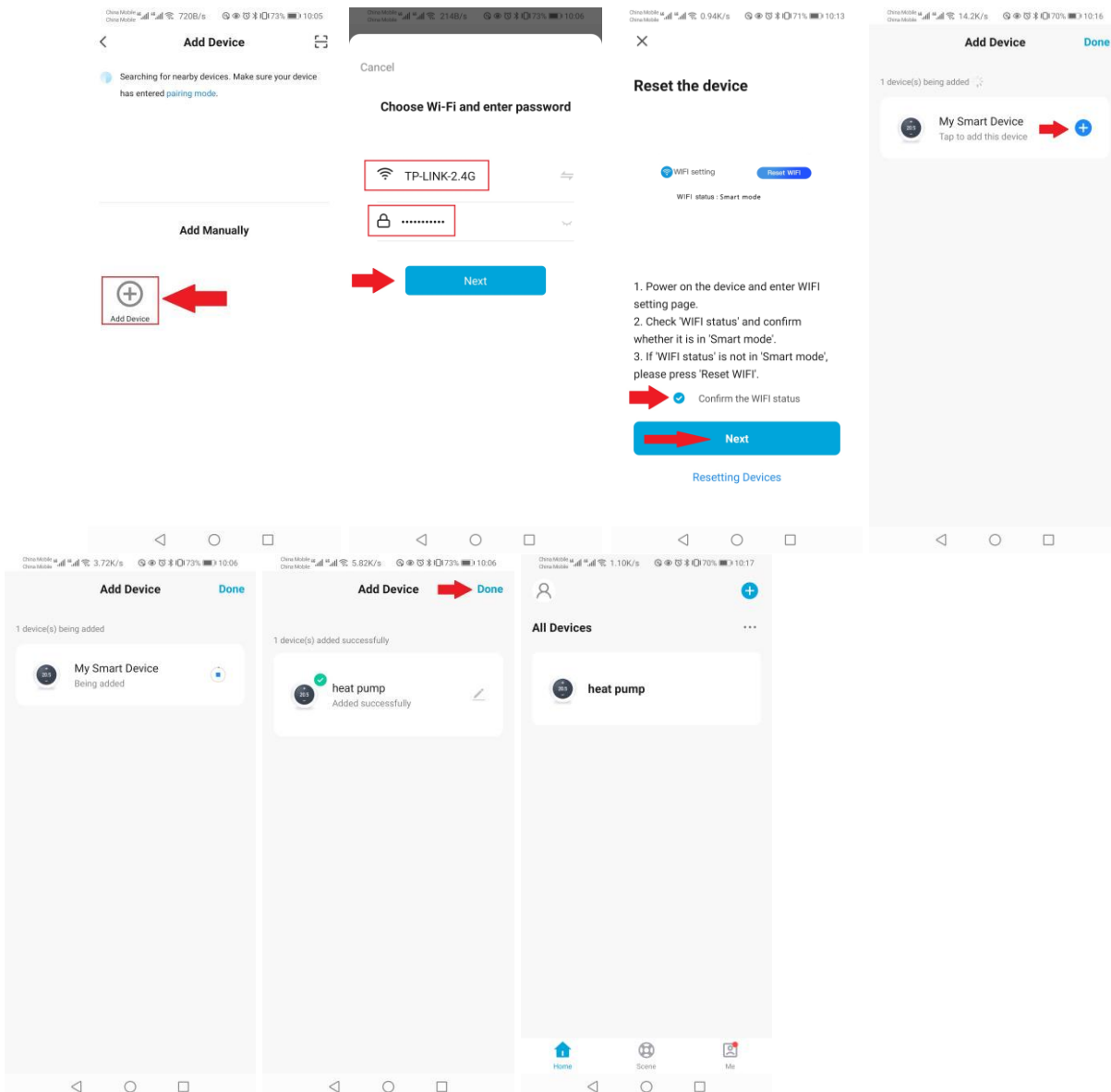

9.10 temp curve

Table1 Heating low temp curve(Heating Ambient Temp-Set Temp) unit: °C

Ambient Temp(TA)	≤-20	-19	-18	-17	-16	-15	-14	-13	-12	-11	-10	-9	-8	-7	-6	-5	-4	-3	-2	-1	0
CURVE#1.L	38	38	38	38	38	37	37	37	37	37	37	36	36	36	36	36	36	35	35	35	35
CURVE#2.L	37	37	37	37	37	36	36	36	36	36	36	35	35	35	35	35	35	34	34	34	34
CURVE#3.L	36	36	36	35	35	35	35	35	35	34	34	34	34	34	34	33	33	33	33	33	33
CURVE#4.L	35	35	35	34	34	34	34	34	34	33	33	33	33	33	33	32	32	32	32	32	32
CURVE#5.L	34	34	34	33	33	33	33	33	33	32	32	32	32	32	32	31	31	31	31	31	31
CURVE#6.L	32	32	32	32	31	31	31	31	31	31	31	31	30	30	30	30	30	30	30	30	29
CURVE#7.L	31	31	31	31	30	30	30	30	30	30	30	30	29	29	29	29	29	29	29	29	28
CURVE#8.L	29	29	29	29	28	28	28	28	28	28	28	28	27	27	27	27	27	27	27	27	26
Ambient Temp(TA)	1	2	3	4	5	6	7	8	9	10	11	12	13	14	15	16	17	18	19	≥20	
CURVE#1.L	35	35	34	34	34	34	34	34	33	33	33	33	33	33	32	32	32	32	32	32	
CURVE#2.L	34	34	33	33	33	33	33	33	32	32	32	32	32	32	31	31	31	31	31	31	
CURVE#3.L	32	32	32	32	32	32	31	31	31	31	31	31	30	30	30	30	30	30	29	29	
CURVE#4.L	31	31	31	31	31	31	30	30	30	30	30	30	29	29	29	29	29	29	28	28	
CURVE#5.L	30	30	30	30	30	30	29	29	29	29	29	29	28	28	28	28	28	28	27	27	
CURVE#6.L	29	29	29	29	29	29	28	28	28	28	28	28	27	27	27	27	27	27	26	26	
CURVE#7.L	28	28	28	28	28	28	27	27	27	27	27	27	26	26	26	26	26	26	25	25	
CURVE#8.L	26	26	26	26	26	26	26	25	25	25	25	25	25	25	25	24	24	24	24	24	

Table2 Heating High temp curve(Heating Ambient Temp-Set Temp) unit: °C

Ambient Temp(TA)	≤ 20	-19	-18	-17	-16	-15	-14	-13	-12	-11	-10	-9	-8	-7	-6	-5	-4	-3	-2	-1	0
CURVE#1.H	55	55	55	55	54	54	54	54	54	54	54	54	53	53	53	53	53	53	53	53	52
CURVE#2.H	53	53	53	53	52	52	52	52	52	52	52	52	51	51	51	51	51	51	51	51	50
CURVE#3.H	52	52	52	52	51	51	51	51	51	51	51	51	50	50	50	50	50	50	50	50	49
CURVE#4.H	50	50	50	50	49	49	49	49	49	49	49	49	48	48	48	48	48	48	48	48	47
CURVE#5.H	48	48	48	48	47	47	47	47	47	47	47	47	46	46	46	46	46	46	46	46	45
CURVE#6.H	45	45	45	45	44	44	44	44	44	44	44	44	43	43	43	43	43	43	43	43	42
CURVE#7.H	43	43	43	43	42	42	42	42	42	42	42	42	41	41	41	41	41	41	41	41	40
CURVE#8.H	40	40	40	40	39	39	39	39	39	39	39	39	38	38	38	38	38	38	38	38	37
Ambient Temp(TA)	1	2	3	4	5	6	7	8	9	10	11	12	13	14	15	16	17	18	19	≥20	
CURVE#1.H	52	52	52	52	52	52	52	51	51	51	51	51	51	51	51	50	50	50	50	50	
CURVE#2.H	50	50	50	50	50	50	50	49	49	49	49	49	49	49	49	48	48	48	48	48	
CURVE#3.H	49	49	49	49	49	49	49	48	48	48	48	48	48	48	48	47	47	47	47	47	
CURVE#4.H	47	47	47	47	47	47	47	46	46	46	46	46	46	46	46	45	45	45	45	45	
CURVE#5.H	45	45	45	45	45	45	45	44	44	44	44	44	44	44	44	43	43	43	43	43	
CURVE#6.H	42	42	42	42	42	42	42	41	41	41	41	41	41	41	41	40	40	40	40	40	
CURVE#7.H	40	40	40	40	40	40	40	39	39	39	39	39	39	39	39	38	38	38	38	38	
CURVE#8.H	37	37	37	37	37	37	37	36	36	36	36	36	36	36	36	35	35	35	35	35	

The heating curve 9 is an automatic setting curve (linear curve generated by setting parameters), calculated as below:

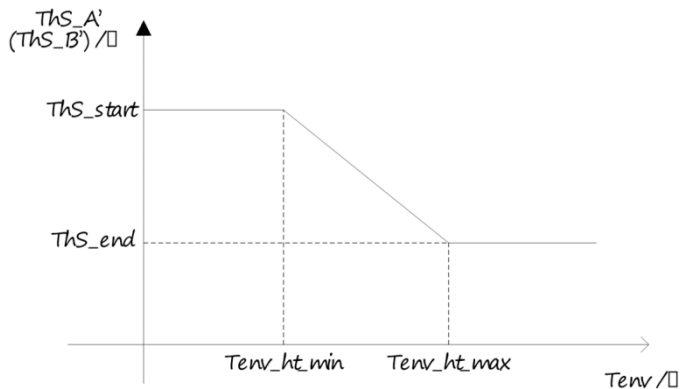

Index 1: Tenv_ht_max: MAX(【Heating ambient temp 1】 , 【Heating ambient temp 2】)
 Tenv_ht_min: MIN(【Heating ambient temp 1】 , 【Heating ambient temp 2】)
 ThS_end: MIN(【Heating hot water temp 2】 , 【Heating hot water temp 1】)
 ThS_start: MAX(【Heating hot water temp 2】 , 【Heating hot water temp 1】)

Index 2: MAX(A,B) Take the larger of A and B
 MIN(A,B) Take the smaller of A and B

Table3 Cooling low temp curve(Cooling Ambient Temp-Set Temp) unit: °C

Ambient Temp(TA)	-10≤TA<15	15≤TA<22	22≤TA<30	30≤TA
CURVE#1.L	16	11	8	5
CURVE#2.L	17	12	9	6
CURVE#3.L	18	13	10	7
CURVE#4.L	19	14	11	8
CURVE#5.L	20	15	12	9
CURVE#6.L	21	16	13	10
CURVE#7.L	22	17	14	11
CURVE#8.L	23	18	15	12

Table3 Cooling high temp curve(Cooling Ambient Temp-Set Temp) unit: °C

Ambient Temp(TA)	-10≤TA<15	15≤TA<22	22≤TA<30	30≤TA
CURVE#1.H	20	18	17	16
CURVE#2.H	21	19	18	17
CURVE#3.H	22	20	19	17
CURVE#4.H	23	21	19	18
CURVE#5.H	24	21	20	18
CURVE#6.H	24	22	20	19
CURVE#7.H	25	22	21	19
CURVE#8.H	25	23	21	20

The cooling curve 9 is an automatic setting curve (linear curve generated by setting parameters), calculated as below:

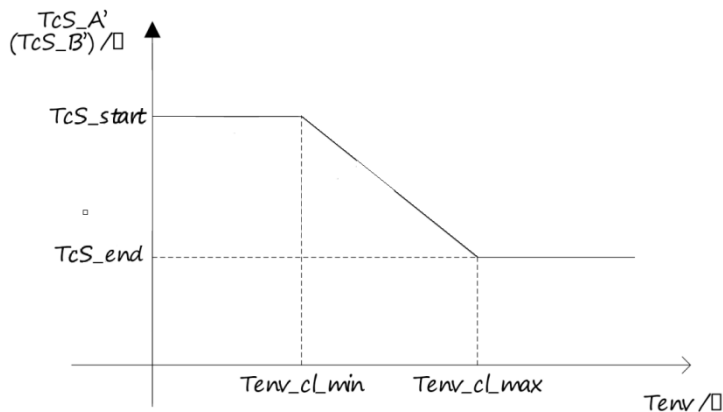

Index 1: Tenv_cl_max: MAX(【Cooling ambient temp 1】 , 【Cooling ambient temp 2】)
 Tenv_cl_min: MIN(【Cooling ambient temp 1】 , 【Cooling ambient temp 2】)
 ThS_end: MIN(【Cooling hot water temp 2】 , 【Cooling hot water temp 1】)
 ThS_start: MAX(【Cooling hot water temp 2】 , 【Cooling hot water temp 1】)

Index 2: MAX(A,B) Take the larger of A and B
 MIN(A,B) Take the smaller of A and B

9.11 Explanation of Abbreviations

Mean	Abbreviation
Ambient temperature	T4
Fin temperature / Wing temp	T3
Suction temperature	Th
Exhaust temperature	Tp
Temperature of plate exchange water / water inlet temp	TWin1
Water outlet temperature of plate exchange / water outlet temp	TWout1
Total outlet water temperture of the system / Total outlet watter temp	TWout
Temperture of hot water tank / Hot water bank temp	THWt
Buffer water tank temperature / Heating water tank temp	TACt
Main expansion valve	EEVm
Auxiliary expansion valve	EVla
High voltage switch	HP
Low voltage switch	LP
Four-way valve	4RV
Crankshaft heating belt	QZH1
Auxiliary heating	IBH / AEH
Chassis heating belt	DPH
Low pressure sensor	LPT
High pressure sensor	HPT
Water pump	PUMPF / CWP
Water flow switch	FS
Frequency conversion fan	DC-FAN
Hot water heating conversion 3-way valve	SV1 / 3RV

10. TEST RUN AND FINAL CHECKS

The installer is obliged to verify correct operation of unit after installation.

1) Final checks

Before switching on the unit, read following recommendations:

- When the complete installation and all necessary settings have been carried out, close all front panels of the unit and refit the unit cover.
- The service panel of the switch box may only be opened by a licensed electrician for maintenance purposes.

NOTE

That during the first running period of the unit, required power input may be higher than stated on the nameplate of the unit This phenomenon originates from the compressor that needs elapse of a 50 hours run in period before reaching smooth operation and stable power consumption.

2) Test run operation (manually)

If required, the installer can perform a manual test run operation at any time to check correct operation of air purge, heating, cooling and domestic water heating.

11. MAINTENANCE AND SERVICE

In order to ensure optimal availability of the unit, a number of checks and inspections on the unit and the field wiring have to be carried out at regular intervals.

This maintenance needs to be carried out by your local technician.

In order to ensure optimal availability of the unit, a number of checks and inspections on the unit and the field wiring have to be carried out at regular intervals.

This maintenance has to be carried out by your local technician.

DANGER

ELECTRIC SHOCK

- Before carrying out any maintenance or repairing activity, must switch off the power supply on the supply panel.
- Do not touch any live part for 10 minutes after the power supply is turned off.
- The crank heater of compressor may operate even in standby.
- Please note that some sections of the electric component box are hot.
- Forbid touch any conductive parts.
- Forbid rinse the unit. It may cause electric shock or fire.
- Forbid leave the unit unattended when service panel is removed.settings.

The following checks must be performed at least once a year by qualified person.

- Water pressure
- Check the water pressure, if it is below 1 bar.fill water to the system.
- Water filter
- Clean the water filter.
- Water pressure relief valve
- Check for correct operation of the pressure relief valve by turning the black knob on the valve counter-clockwise:

-If you do not hear a clacking sound, contact your local dealer.

-In case the water keeps running out of the unit, close both the water inlet and outlet shut-off valves first and then contact your local dealer.

- Pressure relief valve hose
Check that the pressure relief valve hose is positioned appropriately to drain the water.
- Backup heater vessel insulation cover

Check that the backup heater insulation cover is fastened tightly around the backup heater vessel.

- Domestic hot water tank pressure relief valve (field supply) Applies only to installations with a domestic hot water tank. Check for correct operation of the pressure relief valve on the domestic hot water tank. Check that the pressure relief valve hose is positioned appropriately to drain the water.

- Backup heater vessel insulation cover

Check that the backup heater insulation cover is fastened tightly around the backup heater vessel.

- Domestic hot water tank pressure relief valve (field supply) Applies only to installations with a domestic hot water tank . Check for correct operation of the pressure relief valve on the domestic hot water tank.

12. TURN OVER TO CUSTOMER

The owner's manual must be turned over to the customer. Explain the contents in the owner's manual to the customers in details.

WARNING

Ask your dealer for installation of the heat pump.

- Incomplete installation performed by yourself may result in a water leakage, electric shock, and fire.

Ask your dealer for improvement, repair, and maintenance.

- Incomplete improvement, repair, and maintenance may result in a water leakage, electric shock, and fire.
- In order to avoid electric shock, fire or injury, or if you detect any abnormality such as smell of fire, turn off the power supply and call your dealer for instructions.
- Never let the indoor unit or the remote controller get wet.
It may cause an electric shock or a fire.
- Never press the button of the remote controller with a hard, pointed object.
The remote controller may be damaged.
- Never replace a fuse with that of wrong rated current or other wires when a fuse blows out.
Use of wire or copper wire may cause the unit to break down or cause a fire.
- It is not good for your health to expose your body to the air flow for a long time.
- Do not insert fingers, rods or other objects into the air inlet or outlet.
- When the fan is rotating at high speed, it will cause injury.
- Never use a flammable spray such as hair spray, lacquer or paint near the unit.
It may cause a fire.
Never put any objects into the air inlet or outlet.
Objects touching the fan at high speed can be dangerous.
- Do not dispose this product as unsorted municipal waste. Collection of such waste separately for special treatment is necessary.

Do not dispose of electrical appliances as unsorted municipal waste, use separate collection facilities. Contact your local government for information regarding the connection systems available.

- If electrical appliances are disposed of in landfills or dumps, hazardous substances can leak into the ground and get into the food chain, damaging your health and well-being.
- To prevent refrigerant leak, contact your dealer.

When the system is installed and runs in a small room, it is required to keep the concentration of the refrigerant, if by any chance coming out, below the limit. Otherwise, oxygen in the room may be affected, resulting in a serious accident.

- The refrigerant in the heat pump is safe and normally does not leak.

If the refrigerant leaks in the room, contact with a fire of a burner, a heater or a cooker may result in a harmful gas.

- Turn off any combustible heating devices, ventilate the room, and contact the dealer where you purchased the unit.
- Do not use the heat pump until a service person confirms that the portion where the refrigerant leaks is repaired.

CAUTION

- Do not use the heat pump for other purposes.
- In order to avoid any quality deterioration, do not use the unit for cooling precision instruments, food, plants, animals or works of art.
- Before cleaning, be sure to stop the operation, turn the breaker off or pull out the supply cord. Otherwise, an electric shock and injury may result.
- In order to avoid electric shock or fire, make sure that an earth leak detector is installed. Be sure the heat pump is grounded.
In order to avoid electric shock, make sure that the unit is grounded and that the earth wire is not connected to gas or water pipe, lightning conductor or telephone earth wire.
- In order to avoid injury, do not remove the fan guard of the outdoor unit.
- Do not operate the heat pump with a wet hand.
An electric shock may happen.
- Do not touch the heat exchanger fins.
These fins are sharp and could result in cutting injuries.
- Do not place items which might be damaged by moisture under the indoor unit.
Condensation may form if the humidity is above 80%, the drain outlet is blocked or the filter is polluted.
- After a long use, check the unit stand and fitting for damage.
If damaged, the unit may fall and result in injury.
- To avoid oxygen deficiency, ventilate the room sufficiently if equipment with burner is used together with the heat pump.
- Arrange the drain hose to ensure smooth drainage.
Incomplete drainage may cause wetting of the building, furniture etc.
- Never touch the internal parts of the controller.
Do not remove the front panel. Some parts inside are dangerous to touch, and a machine trouble may happen.
- Never do the maintenances work by yourself.
- Please contact your local dealer to do the maintenances work.
- Never expose little children, plants or animals directly to the air flow.
Adverse influence to little children, animals and plants may result.
- Do not allow a child to mount on the outdoor unit or avoid placing any object on it.
Falling or tumbling may result in injury.
- Do not operate the heat pump when using a room fumigation - type insecticide.
Failure to observe could cause the chemicals to become deposited in the unit, which could endanger the health of those who are hypersensitive to chemicals.
- Do not place appliances which produce open fire in places exposed to the air flow from the unit or under the indoor unit.
It may cause incomplete combustion or deformation of the unit due to the heat.

CAUTION

- Do not install the heat pump at any place where flammable gas may leak out.
If the gas leaks out and stays around the heat pump, a fire may break out.
- The appliance is not intended for use by young children or infirm persons without supervision.
Young children should be supervised to ensure that they do not play with the appliance.
- The outdoor unit window-shades should be periodic cleaning in case of being jammed.
This window-shapes is heat dissipation outlet of components, if being jammed will cause the components shorten their service life spans because of overheated for a long time.
- The temperature of refrigerant circuit will be high, please keep the interconnection cable away from the copper tube.

13. OPERATION AND PERFORMANCE

1) Protection Equipment

This Protection Equipment will enable the Heat Pump to stop when the Heat Pump is to be directed running compulsively.

The protection equipment may be activated in following conditions:

Cooling Operation

- The air inlet or air outlet of outdoor unit is blocked.
- Strong wind is Continuously blowing to the air outlet of the outdoor unit.

Heating Operation

Too much rubbish adhere to the filter in the water system.

- The air outlet of indoor unit is choked.
- Mishandling in operation:

If mishandling happens because of lighting or mobile wireless, please shut off the manual power switch, and turn on again, then push the ON/OFF button.

NOTE

When the protection equipment starts, please shut down the manual power switch, and restart operation after problem is solved.

2) About power cut

If power is cut during operation, stop all the operation immediately. Power comes again. If the auto-restart function is set on, then the unit will auto-restart.

3) Heating capacity

- The heating operation is a heat-pump process that heat will be absorbed from outdoor air and released to indoor water. Once the outdoor temperature is decreased, heating capacity decreased correspondingly.
- Other heating equipment is suggested to be used together when outdoor temperature is too low.
In some extreme cold upland that buy the indoor unit equipped with electrical heater will obtain better performance. (Refer to indoor unit owner's manual for details)

NOTE

- The motor in outdoor Unit will continue running for 60 seconds for to remove residual heat when the outdoor Unit receiving OFF command during heating operation.
- If the heat pump malfunction occurs because of disturb, please reconnect the heat pump to power, then turn on it again.

4) Compressor protection feature

A protection feature prevents the heat pump from being activated for approximately several minutes when it restarts immediately after operation.

5) Cooling and heating operation

The the indoor unit in the same system can not run cooling and heating at the same time.

If the Heat Pump Administrator has set running mode, then the heat pump can not run on modes other than the presetted. Standby or No Priority will be displayed in the Control Panel.

6) Features of heating operation

Water will not become hot immediately at the beginning of the heating operation, 3~5 minutes ago (depends on the indoor and outdoor temperature), until the indoor heat exchanger become hot, then becomes hot.

During operation, the fan motor in the outdoor unit may stop running under high temperature.

7) Defrost in the heating operation

During heating operation, outdoor unit sometimes will frost. To increase efficiency, the unit will start defrosting automatically (about 2~10 minutes), and then water will be drained out from outdoor unit.

During defrosting, the fan motors in the outdoor unit will stop running.

14. ERROR CODES

When a safety device is activated, an error code will be displayed on the user interface. A list of all errors and corrective actions can be found in the table below.

Reset the safety by turning the unit OFF and back ON.

In case this procedure for resetting the safety is not successful, contact your local dealer.

Main control class fault:

Error display	Error display	Error display	Error display
EEPROM data error	Insufficient water flow	Return temperature difference is too large	Pressure top temperature probe fault
System maintenance data error	Power supply failure	Return return temperature difference is abnormal	radiator-fan temperature probe fault
frequency converter communication fault	Electric and auxiliary thermal protection	Anti-ice temperature is too low	Exhaust temperature probe fault
Frequency converter failure	Fan protection	Emergency defrosting is frequent	Inspiration temperature probe fault
In the frequency conversion model setting	Press high pressure	Refrigeration and suction is too low	Rear-valve temperature probe failure
Internal and external machine communication failure	Pressure transmission and high pressure is too high	Compressor current is too small	Anti-ice temperature probe failure
Internal and external machine communication is abnormal	Press at low pressure	Compressor current is too large	Economist inlet temperature probe
EX_EC1 communication failure	Pressure transmission pressure is too low	Temperature difference between suction and drainage is abnormal	Economist outlet temperature probe
EX_EC2 communication failure	The exhaust temperature is too high	Refrigeration and evaporation is too low	Low-voltage pressure transmission fault
EX_EC1 failure	The outlet temperature on the air-conditioning side is too low	Environmental temperature probe fault	High pressure pressure transmission fault
EX_EC2 failure	Air conditioning side return temperature is too low	Indoor ring temperature failure	
Fan 1 rotational speed is abnormal	The outlet temperature on the air-conditioning side is too high	Return water temperature probe fault	
Fan 2 rotational speed is abnormal	The return temperature on the side of the air conditioning is too high	Water outlet temperature probe fault	

Frequer converter fault:

Error display	Error display	Error display	Error display
VF01 starts the over-stream	VF10 input is the default phase	VF19D-axis current is too high	VF28 stall failure
VF02 accelerates the overflow	VF11 output is a missing the phase	VF20Q-axis current is too high	VF29 interrupt overflow 1
VF03 slows over flow	VF12 device protection	VF21 storage has failed	VF30 interrupt overflow 2
VF04 constant speed overcurrent	VF13 is overheated	VF22 communication exception	VF31 starts the rotor shake
VF05 accelerates the overpressure	VF14 overload	VF23 current detection	The VF32 runs the rotor to shake
VF06 deceleration and overpressure	VF15 compressor overload	VF25 starts blocking blocking	VF33 frequency conversion PFC overcurrent
VF07 constant speed overpressure	VF17 Overload	VF26 is running blocking	VF34 PFC current is too high
VF08 Overpressure on standby	VF18 speed is too large	VF27 heat dissipation detection	VF35 PFC active current is too high

15. TECHNICAL SPECIFICATIONS

Outdoor Unit

model	Airtherm MONO 9kW	Airtherm MONO 12 kW	Airtherm MONO 15 kW
Power supply	220-240V~ 50Hz		
Rated Power Input	3000W	3700W	5000W
Rated Current Input	13.6A	16.8A	22.7A
Nominal capacity	Refer to the technical data		
Dimensions(mm)	1000×440×765		1100×440×945
Packing(mm)	1178 ×515×920		1278 ×515×1100
Fan motor	DC motor / Horizontal		
Compressor	DC inverter dual rotary		
Heat exchanger	Fin-coil		
Weight			
Net weight	74kg	78kg	91kg
Gross weight	89kg	93kg	107kg
Refrigerant			
Type	R32		
Quantity	1400g	1800g	1800g
Connections			
Heat exchanger	Plate heat exchanger		
Internal water volume	5.0L		
Rated water pressure	0.3MPa		
Filter mesh	60		
Min. water flow (flow switch)	8L/min		
Water inlet/outlet	R1"		
Operation ambient temperature range			
Heating mode	+25~+55°C		
Cooling mode	+5~+20°C		
Domestic hot water mode	+25~+55°C		
Water pressure	0.1 ~ 0.3MPa		

16. INFORMATION SERVICING

1) Checks to the area

Prior to beginning work on systems containing flammable refrigerants, safety checks are necessary to ensure that the risk of ignition is minimised. For repair to the refrigerating system, the following precautions shall be complied with prior to conducting work on the system.

2) Work procedure

Works shall be undertaken under a controlled procedure so as to minimise the risk of a flammable gas or vapour being present while the work is being performed.

3) General work area

All maintenance staff and others working in the local area shall be instructed on the nature of work being carried out, work in confined spaces shall be avoided. The area around the work space shall be sectioned off. Ensure that the conditions within the area have been made safe by control of flammable material.

4) Checking for presence of refrigerant

The area shall be checked with an appropriate refrigerant detector prior to and during work, to ensure the technician is aware of potentially flammable atmospheres. Ensure that the leak detection equipment being used is suitable for use with flammable refrigerants, i.e. no sparking, adequately sealed or intrinsically safe.

5) Presence of fire extinguisher

If any hot work is to be conducted on the refrigeration equipment or any associated parts, appropriate fire extinguishing equipment shall be available to hand. Have a dry power or CO₂ fire extinguisher adjacent to the charging area.

6) No ignition sources

No person carrying out work in relation to a refrigeration system which involves exposing any pipe work that contains or has contained flammable refrigerant shall use any sources of ignition in such a manner that it may lead to the risk of fire or explosion.

All possible ignition sources, including cigarette smoking, should be kept sufficiently far away from the site of installation, repairing, removing and disposal, during which flammable refrigerant can possibly be released to the surrounding space. Prior to work taking place, the area around the equipment is to be surveyed to make sure that there are no flammable hazards or ignition risks. NO SMOKING signs shall be displayed.

7) Ventilated area

Ensure that the area is in the open or that it is adequately ventilated before breaking into the system or conducting any hot work.

A degree of ventilation shall continue during the period that the work is carried out. The ventilation should safely disperse any released refrigerant and preferably expel it externally into the atmosphere.

8) Checks to the refrigeration equipment

Where electrical components are being changed, they shall be fit for the purpose and to the correct specification. At all times the manufacturer's maintenance and service guidelines shall be followed. If in doubt consult the manufacturer's technical department for assistance. The following checks shall be applied to installations using flammable refrigerants:

- The charge size is in accordance with the room size within which the refrigerant containing parts are installed;
- The ventilation machinery and outlets are operating adequately and are not obstructed;
- If an indirect refrigerating circuit is being used, the secondary circuits shall be checked for the presence of refrigerant; marking to the equipment continues to be visible and legible.
- Marking and signs that are illegible shall be corrected;
- Refrigeration pipe or components are installed in a position where they are unlikely to be exposed to any substance which may corrode refrigerant containing components, unless the components are constructed of materials which are inherently resistant to being corroded or are suitably protected against being so corroded.

9) Checks to electrical devices

Repair and maintenance to electrical components shall include initial safety checks and component inspection procedures. If a fault exists that could compromise safety, then no electrical supply shall be connected to the circuit until it is satisfactorily dealt with. If the fault cannot be corrected immediately

but it is necessary to continue operation, and adequate temporary solution shall be used. This shall be reported to the owner of the equipment so all parties are advised.

Initial safety checks shall include:

- That capacitors are discharged: this shall be done in a safe manner to avoid possibility of sparking;
- That there no live electrical components and wiring are exposed while charging, recovering or purging the system;
- That there is continuity of earth bonding.

10) Repairs to sealed components

a) During repairs to sealed components, all electrical supplies shall be disconnected from the equipment being worked upon prior to any removal of sealed covers, etc. If it is absolutely necessary to have an electrical supply to equipment during servicing, then a permanently operating form of leak detection shall be located at the most critical point to warn of a potentially hazardous situation.

b) Particular attention shall be paid to the following to ensure that by working on electrical components, the casing is not altered in such a way that the level of protection is affected. This shall include damage to cables, excessive number of connections, terminals not made to original specification, damage to seals, incorrect fitting of glands, etc.

- Ensure that apparatus is mounted securely.
- Ensure that seals or sealing materials have not degraded such that they no longer serve the purpose of preventing the ingress of flammable atmospheres. Replacement parts shall be in accordance with the manufacturer s specifications.

NOTE

The use of silicon sealant may inhibit the effectiveness of some types of leak detection equipment. Intrinsically safe components do not have to be isolated prior to working on them.

11) Repair to intrinsically safe components

Do not apply any permanent inductive or capacitance loads to the circuit without ensuring that this will not exceed the permissible voltage and current permitted for the equipment in use. Intrinsically safe components are the only types that can be worked on while live in the presence of a flammable atmosphere. The test apparatus shall be at the correct rating. Replace components only with parts specified by the manufacturer. Other parts may result in the ignition of refrigerant in the atmosphere from a leak.

12) Cabling

Check that cabling will not be subject to wear, corrosion, excessive pressure, vibration, sharp edges or any other adverse environmental effects. The check shall also take into account the effects of aging or continual vibration from sources such as compressors or fans.

13) Detection of flammable refrigerants

Under no circumstances shall potential sources of ignition be used in the searching for or detection of refrigerant leaks. A halide torch (or any other detector using a naked flame) shall not be used.

14) Leak detection methods

The following leak detection methods are deemed acceptable for systems containing flammable refrigerants. Electronic leak detectors shall be used to detect flammable refrigerants, but the sensitivity may not be adequate, or may need re-calibration.(Detection equipment shall be calibrated in a refrigerant-free area.) Ensure that the detector is not a potential source of ignition and is suitable for the refrigerant. Leak detection equipment shall be set at a percentage of the LFL of the refrigerant and shall be calibrated to the refrigerant employed and the appropriate percentage of gas (25% maximum) is confirmed. Leak detection fluids are suitable for use with most refrigerants but the use of detergents containing chlorine shall be avoided as the chlorine may react with the refrigerant and corrode the copper pipe-work. If a leak is suspected ,all naked flames shall be removed or extinguished. If a leakage of refrigerant is found which requires brazing, all of the refrigerant shall be recovered from the system, or isolated(by means of shut off valves) in a part of the system remote from the leak . Oxygen free nitrogen(OFN) shall then be purged through the system both before and during the brazing process.

15) Removal and evacuation

When breaking into the refrigerant circuit to make repairs of for any other purpose conventional procedures shall be used, However, it is important that best practice is followed since flammability is a consideration. The following procedure shall be adhered to:

- Remove refrigerant;

- Purge the circuit with inert gas;
- Evacuate;
- Purge again with inert gas;
- Open the circuit by cutting or brazing.

The refrigerant charge shall be recovered into the correct recovery cylinders. The system shall be flushed with OFN to render the unit safe. This process may need to be repeated several times.

Compressed air or oxygen shall not be used for this task.

Flushing shall be achieved by breaking the vacuum in the system with OFN and continuing to fill until the working pressure is achieved, then venting to atmosphere, and finally pulling down to a vacuum. This process shall be repeated until no refrigerant is within the system.

When the final OFN charge is used, the system shall be vented down to atmospheric pressure to enable work to take place.

This operation is absolutely vital if brazing operations on the pipe-work are to take place.

Ensure that the outlet for the vacuum pump is not closed to any ignition sources and there is ventilation available.

16) Charging procedures

In addition to conventional charging procedures, the following requirements shall be followed:

- Ensure that contamination of different refrigerants does not occur when using charging equipment. Hoses or lines shall be as short as possible to minimize the amount of refrigerant contained in them.
- Cylinders shall be kept upright.
- Ensure that the refrigeration system is earthed prior to charging the system with refrigerant.
- Label the system when charging is complete(if not already).
- Extreme care shall be taken not to overfill the refrigeration system.
- Prior to recharging the system it shall be pressure tested with OFN. The system shall be leak tested on completion of charging but prior to commissioning. A follow up leak test shall be carried out prior to leaving the site.

17) Decommissioning

Before carrying out this procedure, it is essential that the technician is completely familiar with the equipment and all its detail.

It is recommended good practice that all refrigerants are recovered safely. Prior to the task being carried out, an oil and refrigerant sample shall be taken.

In case analysis is required prior to re-use of reclaimed refrigerant. It is essential that electrical power is available before the task is commenced.

a) Become familiar with the equipment and its operation.

b) Isolate system **electrically**

c) Before attempting the procedure ensure that:

- Mechanical handling equipment is available, if required, for handling refrigerant cylinders;
- All personal protective equipment is available and being used correctly;
- The recovery process is supervised at all times by a competent person;
- Recovery equipment and cylinders conform to the appropriate standards.

d) Pump down refrigerant system, if possible.

e) If a vacuum is not possible, make a manifold so that refrigerant can be removed from various parts of the system.

f) Make sure that cylinder is situated on the scales before recovery takes place.

g) Start the recovery machine and operate in accordance with manufacturer's instructions.

h) Do not overfill cylinders. (No more than 80% volume liquid charge).

i) Do not exceed the maximum working pressure of the cylinder, even temporarily.

j) When the cylinders have been filled correctly and the process completed, make sure that the cylinders and the equipment are removed from site promptly and all isolation valves on the equipment are closed off.

k) Recovered refrigerant shall not be charged into another refrigeration system unless it has been cleaned and checked.

18) Labelling

Equipment shall be labelled stating that it has been de-commissioned and emptied of refrigerant. The label shall be dated and signed. Ensure that there are labels on the equipment stating the equipment contains flammable refrigerant.

19) Recovery

When removing refrigerant from a system, either for service or decommissioning, it is recommended good practice that all refrigerants are removed safely.

When transferring refrigerant into cylinders, ensure that only appropriate refrigerant recovery cylinders are employed. Ensure that the correct numbers of cylinders for holding the total system charge are available. All cylinders to be used are designated for the recovered refrigerant and labelled for that refrigerant (i.e. special cylinders for the recovery of refrigerant). Cylinders shall be complete with pressure relief valve and associated shut-off valves in good working order.

Empty recovery cylinders are evacuated and, if possible, cooled before recovery occurs.

The recovery equipment shall be in good working order with a set of instructions concerning the equipment that is at hand and shall be suitable for the recovery of flammable refrigerants. In addition, a set of calibrated weighing scales shall be available and in good working order.

Hoses shall be complete with leak-free disconnect couplings and in good condition. Before using the recovery machine, check that it is in satisfactory working order, has been properly maintained and that any associated electrical components are sealed to prevent ignition in the event of a refrigerant release. Consult manufacturer if in doubt.

The recovered refrigerant shall be returned to the refrigerant supplier in the correct recovery cylinder, and the relevant Waste Transfer Note arranged. Do not mix refrigerants in recovery units and especially not in cylinders.

If compressors or compressor oils are to be removed, ensure that they have been evacuated to an acceptable level to make certain that flammable refrigerant does not remain within the lubricant. The evacuation process shall be carried out prior to retraining the compressor to the suppliers. Only electric heating to the compressor body shall be employed to accelerate this process. When oil is drained from a system, it shall be carried out safely.

20) Transportation, marking and storage for units

Transport of equipment containing flammable refrigerants Compliance with the transport regulations

Marking of equipment using signs Compliance with local regulations

Disposal of equipment using flammable refrigerants Compliance with national regulations

Storage of equipment/appliances

The storage of equipment should be in accordance with the manufacturer's instructions.

Storage of packed (unsold) equipment

Storage package protection should be constructed such that mechanical damage to the equipment inside the package will not cause a leak of the refrigerant charge.

The maximum number of pieces of equipment permitted to be stored together will be determined by local regulation.