

BRL65Z-FL

Wall louvre with flange with 65 Z-blade



TECHNICAL DETAILS	
Profile	Extruded alu profiles EN AW-6060 T66 (AlMgSi0.5 F22)
Profile thickness	min. 1,4 mm
Height of the blade	82 mm
Blade pitch	65 mm
Depth to fit	84 mm
Flange depth	33,8 mm
Visual free area	78%
Physical free area	53%
Stainless steel mesh	RVS (AISI 304) with apertures 2.3 x 2.3 mm
Reinforcement	Louvres wider than 700 mm are provided with a reinforcement profile carrying additional blade supports to strengthen the wide louvre
INSTALLATION	
Brackets (supplied as standard)	
SHAPES	
Rectangular. square	
OPTIONS	
Insect mesh; water gutter.	

DIMENSIONS
Min. dimension (height x width): 200 x 200 mm
Max. dimension (height x width): 2000 x 4000 mm
Other dimensions on request

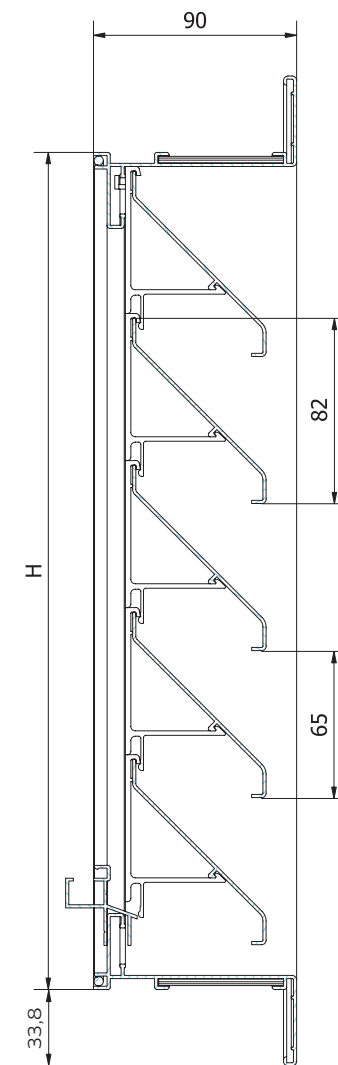

FL